



PETREL • 3



Recreational Modes Operating Instructions



Powerful • Simple • Reliable



Table of Contents

Table of Contents	2
Conventions Used in this Manual	3
1. Introduction	4
1.1. Notes on this manual	5
1.2. Modes Covered by this Manual	5
1.3. Models Covered by this Manual	5
2. Basic Operation	6
2.1. Turning On	6
1.4. Customizable Splash Screen	6
2.2. Buttons	7
2.3. Changing between Modes	8
3. Dive Interface	9
3.1. Default Dive Setup	9
3.2. Dive Mode Differentiation	9
3.3. Main Screen	10
3.4. Detailed Descriptions	11
3.5. Mini Displays	14
3.6. Info Screens	15
3.7. Info Screen Descriptions	16
3.8. Notifications	21
3.9. Customizable Alerts	23
3.10. List of primary notifications	24
4. Safety and Decompression Stops	26
4.1. Safety Stops	26
4.2. Decompression Stops	27
5. Decompression and Gradient Factors ...	28
5.1. Decompression Information Accuracy	29
6. Example Dives	30
6.1. Single Gas Example Dive	30
6.2. Multi-Gas Example Dive	31
7. Gauge Mode	33
8. Compass	34

9. Air Integration (AI)	35
9.1. What is AI?	35
9.2. Basic AI Setup	36
9.3. AI Displays	39
9.4. Sidemount AI	41
9.5. Using Multiple Transmitters	42
9.6. SAC calculations	43
9.7. GTR calculations	44
9.8. Transmitter Connection Issues	45
10. Menus	46
10.1. Menu Structure	46
10.2. Turn off	47
10.3. Select Gas (3 GasNx only)	47
10.4. Dive Setup	48
10.5. Dive Log	51
11. System Setup Reference	52
11.1. Mode Setup	53
11.2. Deco Setup	54
11.3. AI Setup	55
11.4. Bottom Row	57
11.5. Nitrox Gases	57
11.6. Alerts Setup	57
11.7. Display Setup	58
11.8. Compass	58
11.9. System Setup	59
11.10. Advanced Config	60
12. Firmware Update and Log Download	62
12.1. Shearwater Cloud Desktop	62
12.2. Shearwater Cloud Mobile	64
13. Changing the Battery	65
13.1. Behavior on Battery Change	66
14. Storage and Maintenance	67
15. Servicing	67
16. Glossary	67
17. Petrel 3 Specifications	68
18. Regulatory Information	68
19. Contact	69



DANGER

This computer is capable of calculating decompression stop requirements. These calculations are at best a guess of real physiological decompression requirements. Dives requiring staged decompression are substantially riskier than dives that stay well within no-stop limits. Diving with rebreathers and/or diving mixed gases and/or performing staged decompression dives and/or diving in overhead environments greatly increases the risk associated with scuba diving.

YOU REALLY ARE RISKING YOUR LIFE WITH THIS ACTIVITY.

! WARNING

This computer has bugs. Although we haven't found them all yet, they are there. It is certain that there are things that this computer does that either we didn't think about or planned for it to do something different. Never risk your life on only one source of information. Use a second computer or tables. If you choose to make riskier dives, obtain the proper training and work up to them slowly to gain experience.

This computer will fail. It is not whether it will fail but when it will fail. Do not depend on it. Always have a plan for how to handle failures. Automatic systems are no substitute for knowledge and training.

No technology will keep you alive. Knowledge, skill, and practiced procedures are your best defense (except for not doing the dive, of course).



Conventions Used in this Manual

These conventions are used to highlight important information:



INFORMATION

Information boxes contain useful tips for getting the most out of your Petrel 3.



CAUTION

Caution boxes contain important instructions for operating your dive computer.



WARNING

Warning boxes contain critical information that may affect your personal safety.



1. Introduction

The Shearwater Petrel 3 is a dive computer for beginner to expert divers.

Please take the time to read this manual. Your safety may depend on your ability to read and understand your dive computer's displays.

Diving involves risk and education is your best tool for managing this risk.

Do not use this manual as a substitute for proper dive training and never dive beyond your training. What you don't know can hurt you.

Features

- High-contrast 2.6" AMOLED display
- Rugged computer construction
- Titanium bezel
- User replaceable battery
- Powerful vibration alerts
- Programmable depth sampling rates
- Depth sensor calibrated to 130 msw
- Depth sensor function past 300 msw
- Crush pressure rating of 290 msw
- 5 customizable gases in technical diving modes
- Any combination of Oxygen, Nitrogen and Helium (Air, Nitrox, Trimix)
- Full decompression and CCR Support
- External PPO2 monitoring of 1, 2 or 3 oxygen cells (Ext. Models Only)
- Bailout rebreather mode (Ext. Models Only)
- Bühlmann ZHL-16C with gradient factors standard
- Optional VPM-B and DCIEM decompression models
- No lockout for violating deco stops
- CNS Tracking
- Gas Density Tracking
- Quick NDL and full decompression planner built in
- Simultaneous wireless pressure monitoring of up to 4 cylinders
- Sidemount diving features
- Tilt compensated digital compass with multiple display options
- Bluetooth Dive log uploading to Shearwater Cloud
- Free firmware updates



1.1. Notes on this manual

This manual provides operating instructions for the Petrel 3 dive computer in recreational operating modes only.

This manual contains cross-references between sections to make it easier to navigate.

Underlined text indicates the presence of a link to another section.

Do not change any settings on your Petrel 3 without understanding the consequence of the change. If you are unsure, consult the appropriate section of the manual for reference.

This manual is not a substitute for proper training.



Firmware Version: V91

This manual corresponds to firmware version V91.

Feature changes may have been made since this release and might not be documented here.

Check the release notes on Shearwater.com for a complete list of changes since the last release.

1.2. Modes Covered by this Manual

This manual provides operating instructions for the Petrel 3 in the following recreational operating modes:

- Air
- Nitrox
- 3 GasNx
- Gauge

The Shearwater Petrel 3 also has several modes designed for open circuit technical and closed circuit rebreather diving.

For detailed instructions on operation in technical diving modes, please see the [Petrel 3 Technical Mode Manual](#).



Some features of the Petrel 3 only apply to certain dive modes.

If not otherwise indicated, features described are applicable in all dive modes.

Change the Dive Mode from the Mode Setup menu. See details on page 53.

1.3. Models Covered by this Manual

This manual provides operating instructions for the following Petrel 3 models in recreational modes:

- Stand Alone Model 
- Fischer Connector Model 
- Analog Cable Gland Model 

Recreational mode features apply to all listed models.



2. Basic Operation

2.1. Turning On

To turn the Petrel 3 on, press both buttons together.



Auto-on

The Petrel 3 will automatically turn on when submerged underwater. This is based on pressure increase and not on the presence of water. When auto-on is activated, the Petrel 3 will enter the last configured dive mode.



Do Not Rely On The Auto-On Feature

This feature is supplied as a backup for when you forget to turn on your Petrel 3.

Shearwater recommends turning your computer on manually before each dive to confirm proper operation and to double check battery status and setup.

Auto-on Details

The Petrel 3 turns on automatically and enters dive mode when the absolute pressure is greater than 1100 millibar (mbar).

For reference, normal sea level pressure is 1013 mbar and 1 mbar of pressure corresponds to approximately 1 cm (0.4") of water. So, when at sea level, the Petrel 3 will automatically turn-on and enter dive mode when about 0.9 m (3 ft) underwater.

If at higher altitude, then the Petrel 3 auto-on will occur at a deeper depth. For example, when at 2000 m (6500 ft) altitude the atmospheric pressure is only about 800 mbar. Therefore, at this altitude the Petrel 3 must be submerged underwater by 300 mbar to reach an absolute pressure of 1100 mbar. This means the auto-on occurs at about 3 m (10 ft) underwater when at an altitude of 2000 m.

1.4. Customizable Splash Screen

After turning on, the Petrel 3 Splash Screen is displayed for 2 seconds.

Customizable start up text can be added using the Shearwater Cloud Desktop app.

The image itself can also be customized using the Shearwater Cloud Desktop App.

Note that the computer will revert to the standard splash screen on a firmware update. The custom splash screen will then need to be reloaded.

See the section on [Firmware Update and Log Download](#) on page 62 for details.



2.2. Buttons

Two titanium piezo-electric buttons are used to change settings and view menus.

All Petrel 3 operations are simple single button presses.



MENU (left) button

SELECT (right) button

Don't worry about remembering all the button rules below. Button hints make using the Petrel 3 easy.

MENU (Left) button

From main screen	Brings up menu
In a menu	Moves to the next menu item
Editing a setting	Changes the setting's value

SELECT (Left) button

From main screen	Steps through info screens
In a menu	Performs command or starts editing
Editing a setting	Saves the setting's value

BOTH BUTTONS

When Petrel 3 is off pressing MENU and SELECT at the same time will turn the Petrel 3 on. No other operation requires pressing both buttons at the same time.

Button Hints

When in a menu, button hints indicate the function of each button:

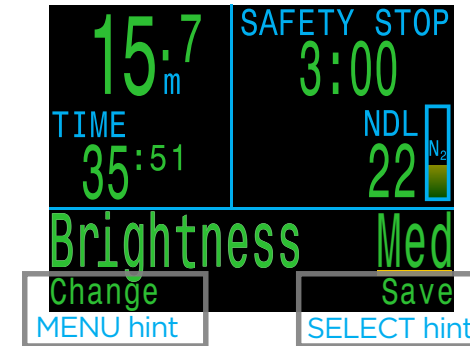

In the example above, the hints tell us:

- Use MENU to change the brightness value
- Use SELECT to save the current value



2.3. Changing between Modes

By default the Petrel 3 is set to 3 GasNx Mode.



3 GasNX Mode



OC Tec Mode

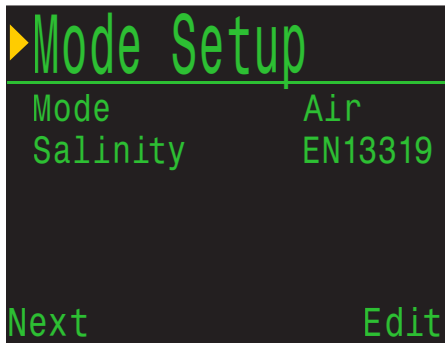

Mode Setup Menu

This is the most complex of the recreational focused dive modes. All recreational modes can be distinguished by their large-font layout.

This manual covers operation in recreational diving modes only.

Technical modes have a dense layout compared to recreational modes. This provides space for additional information required for technical diving at the expense of font size.

For directions on how to use the technical focused modes on the Petrel 3, see the [Petrel 3 Technical Modes Manual](#).

Shearwater recommends using the simpler recreational diving layout for simple, single gas no-decompression diving.

Switch between modes in the mode setup menu. See details on page 53.

Mode Selection

The different modes of this computer are designed to fit the needs of different types of divers. If you're just starting out on your diving adventure, we recommend keeping things simple.

If you're diving a single tank with air in it (21% O₂), we recommend you use the Air mode. If diving a single tank of nitrox, we recommend Nitrox mode.

The more advanced modes are more complicated, with more rules that you need to be aware of.



3. Dive Interface

3.1. Default Dive Setup

The Petrel 3 comes pre-configured for recreational diving. The default dive mode is 3 Gas Nitrox mode (3 GasNx).

As a quick reference, a diagram of the default diving display is shown below.

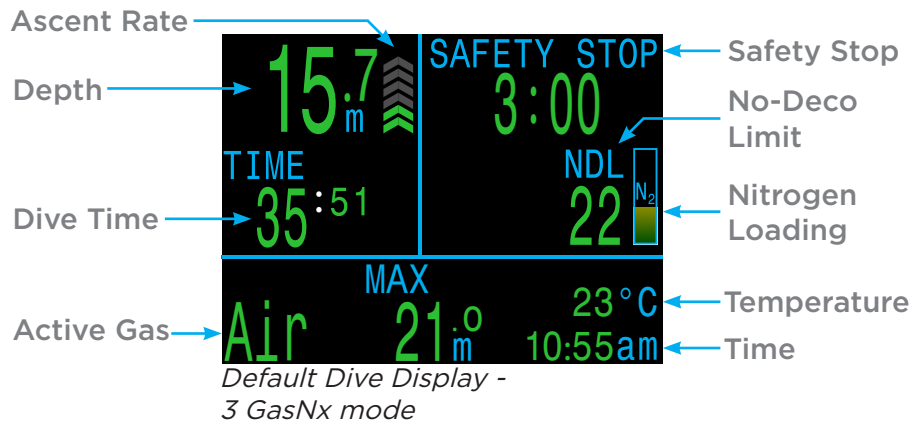

The elements of the above default display are shared by all of the dive modes covered in this manual.

For directions on how to use OC Tec, CC/BO, or other technical dive modes, see the [Petrel 3 Technical Modes Manual](#).

The next section lists all the dive modes available on the Petrel 3 stand alone model. Change the Dive Mode from the Mode Setup menu. [See details on page 53.](#)

For information about other rebreather specific modes used with external oxygen cells, see the [Petrel 3 Technical Modes Manual](#).

3.2. Dive Mode Differentiation

Each dive mode is designed to best suit a particular type of diving.

Air

Designed for use during recreational, air only, no-decompression diving activities.

- Air (21% oxygen) only, not switchable underwater

Nitrox (Single Gas)

Designed for use during recreational, Nitrox, no-decompression diving activities.

- Single Gas Nitrox up to 40% oxygen
- No gas switching underwater

3 GasNx (Three Gas Mode)

Designed for introductory technical diving activities including diving involving planned decompression.

- Three programmable gases
- Support for gas switching
- Nitrox up to 100%

OC Tec

Designed for open circuit technical diving activities including planned decompression.

- Full Trimix
- No Safety stops

CC/BO

Designed for use with a closed circuit rebreather.

- Fast switching from closed circuit to open circuit (BO) operating modes.

Gauge

Gauge Mode turns the Petrel 3 into a simple depth and time display with a dedicated layout (bottom timer). [See details on page 36.](#)

- No tissue tracking
- No decompression information



3.3. Main Screen

The Main Screen shows the most important information for Air and Nitrox diving.

It is divided into three sections: Basic dive info, decompression info, and the Info Row.

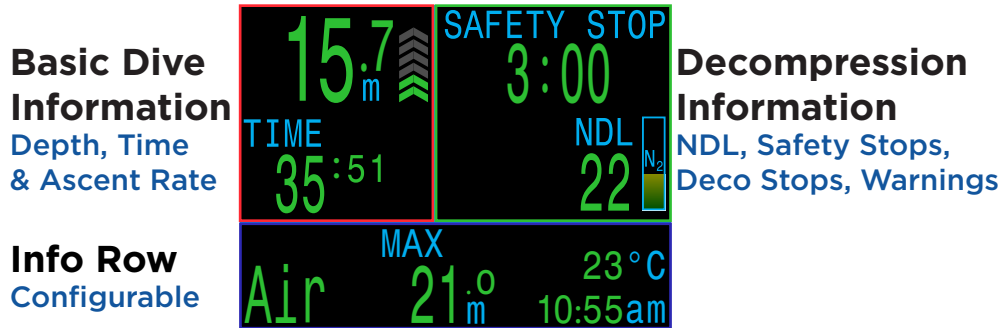

Main Screen Sections

The Basic Dive Info section and the Decompression Info section content are reserved for the most critical information and are fixed. Pressing the right (SELECT) button scrolls through additional data in the Info row.

Basic Dive Info

The Basic Dive area shows:

- The current depth (in feet or meters)
- The dive time in minutes and seconds

When on the surface, the dive time is replaced by a surface interval timer. Also, a battery gauge will appear in this area.

Decompression Info

The Decompression area shows:

- Safety stops (if enabled)
- Decompression stops
- No-Decompression Limit (NDL) in minutes
- Nitrogen loading bar graph
- Warnings for Maximum Operating Depth (MOD) and Central Nervous System oxygen toxicity (CNS)

Configurable Info Row

The bottom-left position on the home screen always shows the currently selected breathing gas.

The center and right positions can be configured to display a variety of different information. By default they show maximum depth, time of day and temperature.

See “Configurable Info Row” on page 13 for customization options.

Pressing the SELECT (right) button will cycle the Info Row through additional data. Pressing the MENU (left) button will return the info row to the home screen.



3.4. Detailed Descriptions

Basic Dive Info Area

The Basic Dive Info Area shows depth, dive time, ascent rate, and state of battery charge (when at the surface).

Depth

The depth is shown in the top left. When in meters, one decimal place is shown.

Note: If the depth shows a Flashing Red zero or shows at depth at the surface, then the depth sensor needs service.



Depth in Meters and Dive Time

Dive Time

Dive time displays in minutes and seconds. It begins and ends counting automatically when you dive.



Depth in Feet and Dive Time

Surface Interval

When on the surface, the dive time is replaced by the surface interval in hours and minutes. Beyond 96 hours(4 days), it displays in days.



The surface interval resets when decompression tissues are cleared.

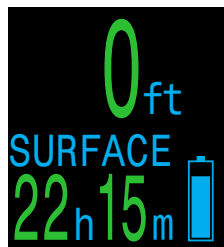

Surface interval and battery symbol

Ascent Rate Display

Shows how fast you are currently ascending graphically.

1 arrow per 3 meters per minute (mpm) or 10 feet per minute (fpm) of ascent rate.



GREEN when less than 9 mpm / 30 fpm (1 to 3 arrows)



YELLOW when greater than 9 mpm / 30 fpm and less than 18 mpm / 60 fpm (4 or 5 arrows)



FLASHING RED when greater than 18 mpm / 60 fpm (6 arrows)

Note: Deco calculations assume 10mpm (33fpm) ascent rate.

Battery Icon

The battery icon is shown on the surface but disappears when diving. If low or critical then the battery icon will appear while diving.



BLUE when battery charge is OK



YELLOW when battery needs to be charged.



RED when battery must be charged immediately.

Due to variations in battery chemistry, battery indicator (fuel gauge) accuracy differs between different battery types. See [Battery Type Selection on page 65](#) for details.



Decompression Info Area

No Decompression Limit (NDL)



The time remaining, in minutes, at the current depth until decompression stops will be necessary.



Displays in Yellow when the NDL is less than the low NDL limit (Default 5 minutes).

Safety Stop

Appears when a safety stop is recommended and counts down automatically when in the safety stop range.

Safety stops may be turned off, set to fixed times of 3, 4, or 5 minutes, set to adapt based on dive conditions, or be set to count up from zero.

See [Safety Stops on page 26](#) for details.

Deco Stop Depth and Time

Once NDL = 0 minutes, mandatory decompression is required. The safety stop counter will be replaced by the shallowest depth to which you can ascend and how long to hold that stop.

See [Decompression Stops on page 27](#) for details.



*NDL > 0 minutes
Safety Stop suggested*

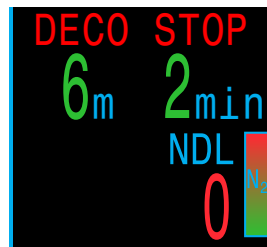

*NDL = 0 minutes
Decompression Stops Required*

Nitrogen Loading bar Graph

The nitrogen bar graph is scaled such that it is full once decompression stops will be needed.

On ascent, it gives a much better indication of decompression stress and the risk of decompression sickness than NDL does.

On the surface, the Nitrogen Loading bar Graph shows the residual nitrogen from the previous dive.

Persistent Notifications

Persistent notifications are displayed to the left of NDL. If multiple warnings are triggered, only the highest priority will display.

See [Notifications on page 21](#) for more information on warnings.

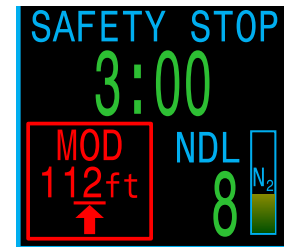

Important!

All decompression information including Deco Stops, NDL, and Time to surface are predictions that assume:

- Ascent rate of 10mpm / 33fpm
- Decompression stops will be followed
- All programmed gases will be used as appropriate

Read more about [Decompression and Gradient Factors on page 28](#).



Configurable Info Row

The Home Screen is the default display for the info row. Information in the center and right positions can be customized.



Active Gas

The active gas position is not configurable. It always shows the currently selected breathing gas.



When air (21% O₂) is used, the value “Air” is displayed.

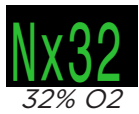

For all other gases, it displays “Nx” (Nitrox) followed by the O₂%.



Better Gas available

The gas will display in yellow if a better gas is available. (3 GasNx mode only)

The gas will display in flashing red if the MOD of the gas has been exceeded.

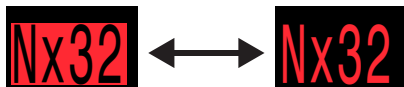

Gas displayed in flashing red when MOD has been exceeded

Configurable Center & Right Positions

Many possible configurations can be set for the center and right positions of the bottom row.

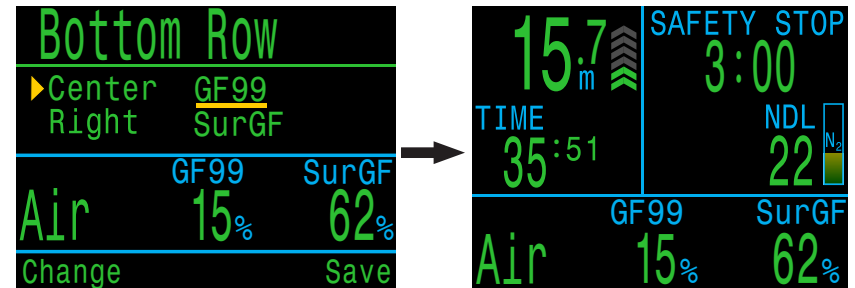

All recreational dive modes share the same home screen customization options. If you customize your home screen in Air mode, that same custom configuration will be present when you put your computer in Nitrox mode.

See details for how to change the configuration of the [Bottom Row on page 57](#).

All bottom row options are listed on the next page. Descriptions of each function can be found in the next section (INFO Screens)



Home Screen Configuration Options

Option	Info Display	Option	Info Display
PPO2	PP02 1.15	CLOCK	CLOCK 12:58
CNS %	CNS 11	Timer	TIMER 0:58
MOD	MOD 57.3 m	Dive End Time	DET 1:31
Gas Density	DENSITY 1.3 g/L	RATE	RATE +43 ft/min
GF99	GF99 15%	Temperature	TEMP 18°C
Surface GF	SurGF 44%	Compass	319°
Ceiling	CEIL 17	Max Depth	MAX 57.0 m
@+5	@+5 20	Avg. Depth	AVG 21.3 m
Δ+5	Δ+5 +8	Tank Pressure	T1 175 BAR
Time To Surface	TTS 15	Surface Air Consumption	SAC T1 1.5 Bar/min
Dil. PPO2	DilP02 .99	Gas Time Remaining	GTR T1 37
FiO2	Fi02 .32	Redundant Time Remaining	RTR T1 16
Mini Display	Δ+5 -4 GF99 37% SfGF 180		

i Mini Displays
 Mini Displays for the left and right custom slots can each hold 3 data displays.

3.5. Mini Displays

Mini displays provide more options for data customization at the expense of font size.

There 2 separately configurable mini displays that are shared by all recreational modes. By default mini display 1 is in the right slot of the bottom row and contains temperature and time.

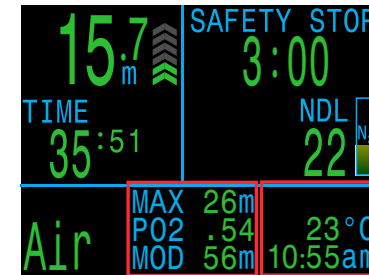

Mini 2 Mini 1

Details about how to customize the mini displays can be found on [page 57](#)

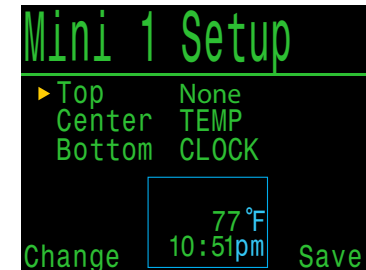

Up to 6 customizable fields can be displayed simultaneously with fully populated Mini Displays, Managed improperly, this can be an overwhelming amount of information.

Care should be taken not to distract from important information such as NDL and gas pressure remaining.



3.6. Info Screens

Info screens provide more information than is available on the main screen.

From the main screen, the SELECT (right) button steps through info screens.

When all info screens have been viewed, pressing SELECT again will return to the main screen.

Info screens also automatically time-out after 10 seconds, returning to the home screen. This prevents active gas information from being hidden for an extended period.

Note that the Compass, Tissues and AI Info screens do not automatically time out when active.

Pressing the MENU (left) button will return to the home screen at any time.

Although these screens are generally representative of the Petrel 3 display, info screen content varies for each mode. For example, decompression related info screens are not available in gauge mode.

The next section gives detailed descriptions of the data elements shown on the info screens.



- Return to Main Screen by:
- Pressing the right (MENU) button
 - Stepping past last screen
 - Waiting 10 Seconds (most screens)

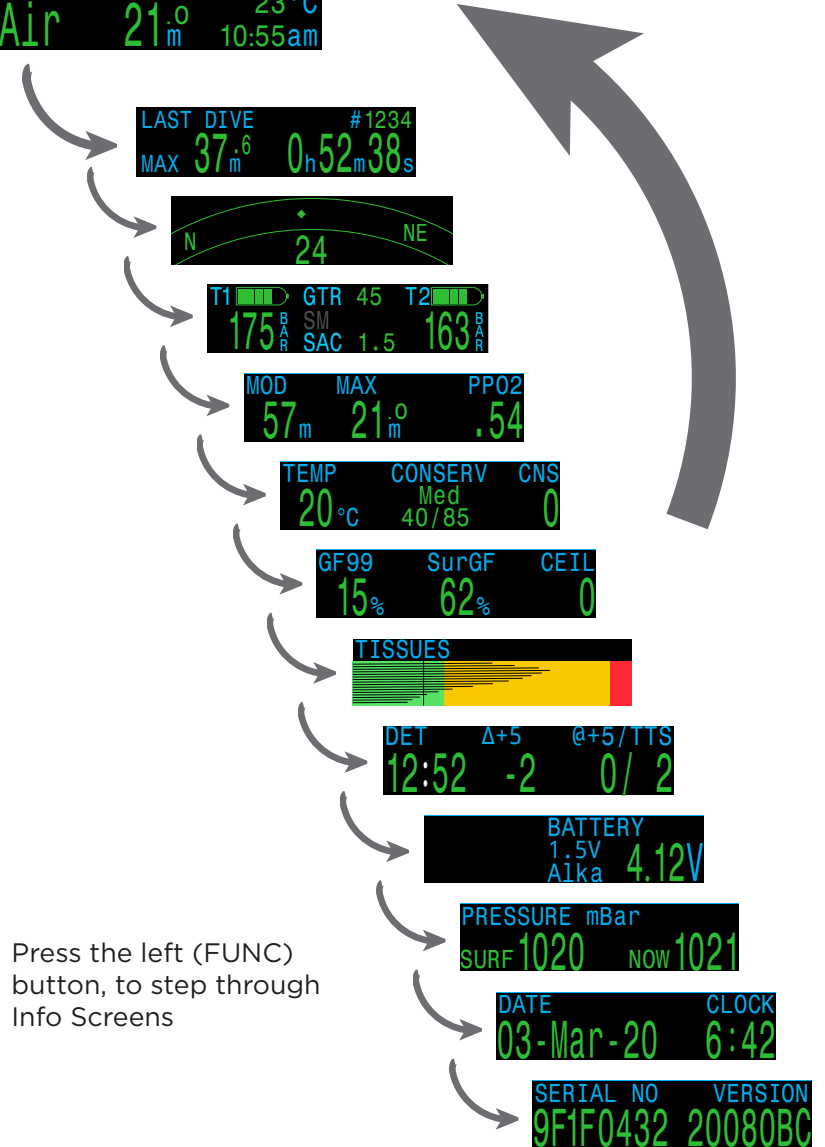



3.7. Info Screen Descriptions

Last Dive Info Screen

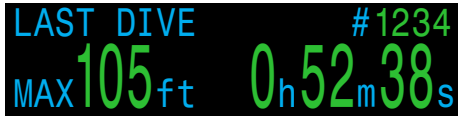

Maximum depth and dive time from the last dive. Only available at the surface.

Air Integration

Only available if AI feature is turned on. The contents of the AI info line will automatically adapt to the current setup. Some examples include:

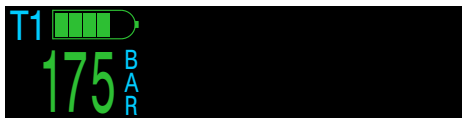

T1 Only

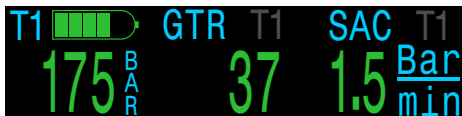

T1 & GTR/SAC



T1 & T2



T1, T2 & GTR/SAC

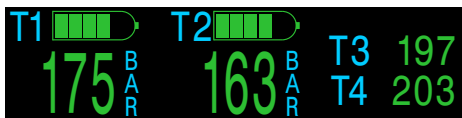

T1, T2, T3, & T4

More information on AI features, limitations, and displays can be found in [the Air Integration \(AI\) section on page 35.](#)

Compass

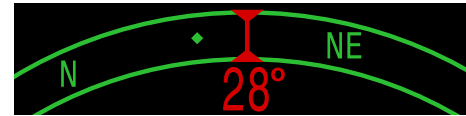

Marked headings appear in green while reciprocal headings are shown in red. Green arrows point in the direction of your mark when off course by 5° or more.

Compass info row will not time out and is only available when compass feature is turned on.

[See the Compass section on page 34 for more information.](#)

Maximum Operating Depth



MOD is the maximum allowable depth of the current breathing gas as determined by PPO2 limits.

Displays in **Flashing Red** when exceeded.

Maximum Depth



The maximum depth of the current dive. When not diving, displays the maximum depth of the last dive

Partial Pressure of Oxygen (PPO2)



PPO2 of the current breathing gas. Displays in **Flashing Red** when outside PPO2 limits.

Temperature

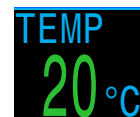

The current temperature in degrees Celsius or degrees Fahrenheit. Temperature units can be set in the Display settings menu.



Conservatism



The conservatism level and values for the Bühlmann GF decompression algorithm.

Read more about [Decompression and Gradient Factors on page 28](#).

CNS Toxicity Percentage

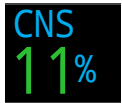

Central Nervous System oxygen toxicity loading percentage (CNS). Turns **Yellow** when greater than 90%. Turns **Red** when greater than 150%.



The CNS percentage is calculated continuously, even when the dive computer is on the surface and turned off. When deco tissues are reset, the CNS will also be reset.

The CNS value (short for Central Nervous System Oxygen Toxicity) is a measure of how long you have been exposed to elevated partial pressures of oxygen (PPO2) as a percentage of a maximum allowable exposure. As PPO2 goes up, the maximum allowable exposure time goes down. The table we use is from the NOAA Diving Manual (Fourth Edition). The computer linearly interpolates between these points and extrapolates beyond them when necessary. Above a PPO2 of 1.65 ATA, the CNS rate increases at a fixed rate of 1% every 4 seconds.

During a dive the CNS never decreases. When back at the surface, a half-life of elimination of 90 minutes is used.

For example, if at the end of the dive the CNS was 80%, then 90 minutes later it will be 40%. In 90 more minutes it will be 20%, etc. Typically, after about 6 half-life times (9 hours), everything has returned close to equilibrium (0%).

GF99



The current gradient factor as a percentage of the controlling compartment m-value (i.e. super-saturation percent gradient)

0% means the leading tissue super-saturation is equal to ambient pressure. Displays “On Gas” when tissue tension is less than the inspired inert gas pressure.

100% means the leading tissue super-saturation is equal to the original M-Value limit in the Bühlmann ZHL-16C model. This should never reach 100%.

GF99 is displayed in **Yellow** when the current gradient factor modified M-Value (GF High) is exceeded.

GF99 is displayed in **Red** when 100% (un-modified M-Value) is exceeded.

GF99 is most interesting to look at during ascent. It can be thought of as a simplified indicator of current decompression stress. GF99 reaches a maximum right when you surface. Surfacing with a lower GF99 is generally thought to be more conservative.

Surface GF



The surfacing gradient factor expected if the diver instantaneously surfaced.

SurGF colour is based on the current GF (GF99). If the current GF is greater than GF High, SurGF will be displayed in **Yellow**. If the current gradient factor is greater than 100%, SurGF will be displayed in **Red**.

If GF99 is an indicator of current decompression stress, SurGF is a predictor of future decompression stress if you were to suddenly surface. SurGF is always interesting to look at, but watching it fall while on your safety stop gives you a sense of the safety stop's effectiveness at reducing risk.



Ceiling



The current decompression ceiling not rounded to the next deeper stop increment. (i.e. not a multiple of 10ft or 3m). Only useful in decompression diving.

Time To Surface



The Time-To-Surface (TTS) in minutes. This is the current time to ascend to the surface including the ascent plus all required deco stops and safety stops.

@+5



“At plus 5” is the TTS if remaining at the current depth for 5 more minutes. This can be used as a measure of how fast you are on-gassing or off-gassing while in decompression.

Δ+5

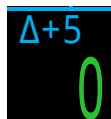

“Delta plus 5” is the predicted change in TTS if you were to stay at the current depth for 5 more minutes. Most useful in decompression.
 $(\Delta+5) = (@+5) - (TTS)$

Dive End Time (DET)



The time of day at which you can expect to surface if you depart immediately, ascend at 10mpm or 33fpm, change gases when prompted, and perform all decompression stops as directed. Most useful in decompression diving where TTS could be high.

Rate



Numerically displays the rate of ascent or decent in feet or meters per minute. Only available in a configurable data location.

Gas Density Display



The Gas Density display is only available as a customizable display and is not available in the info row.

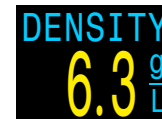

For open circuit diving, the gas density display turns yellow at 6.3 grams per liter. No other warnings are generated.

You may be surprised at how shallow the gas density warning color appears.

Read more about why we chose these levels starting on page 66 here (recommendations on page 73):

[Anthony, T.G and Mitchell, S.J. Respiratory physiology of rebreatherdiving. In: Pollock NW, Sellers SH, Godfrey JM, eds. Rebreathers and Scientific Diving. Proceedings of NPS/NOAA/DAN/AAUS June 16-19, 2015 Workshop. Durham, NC; 2016.](#)

Timer



A simple stopwatch. The timer is only available as a customizable display. It is not available in the info row.

Mini Compass



A small compass that can be displayed at all times. The red arrow always points toward north. Only available as a custom display



Tissues bar Graph



The tissues bar graph shows the tissue compartment inert gas tissue tensions based on the Bühlmann ZHL-16C model.

Each bar represents the nitrogen inert gas tension for one compartment. The fastest tissue compartment is shown on the top, and the slowest on the bottom. Pressure increases to the right.

The vertical black line shows the inspired partial pressure of nitrogen. The green-yellow interface line is the ambient pressure. The yellow-red interface line is the ZHL-16C M-Value pressure.

Tissues that are supersaturated above ambient pressure extend into the yellow, and tissues that are supersaturated above the M-Value extend into the red.

Note that the scale for each tissue compartment is different. The reason the bars are scaled in this way is so that the tissues tensions can be visualized in terms of risk (i.e. how close they are as a percentage to Bühlmann's original super-saturation limits). Also, this scale changes with depth, since the M-Value line also changes with depth.

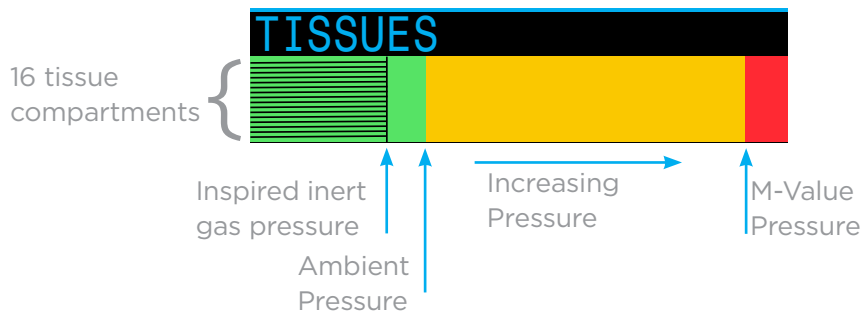

Sample Tissue bar Graphs



On surface (sat. with air)
Note: Gas is 79% N₂ (21% O₂, or Air)



Immediately after descent



On Gassing



Deepest Stop



Last deco Stop
Note: Gas is now 50% O₂ and 50% N₂



Pressure



PRESSURE mBar
SURF 1020 NOW 1021

The pressure in millibar. Two values are shown, the surface (surf) pressure and the current (now) pressure.

Note that typical pressure at sea level is 1013 millibar, although it may vary with the weather (barometric pressure). For example, in a low pressure system surface pressure may be as low as 980 millibar, or as high as 1040 millibar in a high pressure system.

For this reason, the PPO2 displayed on the surface may not exactly match the FO2 (fraction of O2), although the displayed PPO2 is still correct.

The surface pressure is set based on the lowest pressure the Petrel 3 sees in the 10 minutes prior to computer turn on. Therefore, altitude is automatically accounted for and no special altitude setting is required.

Battery

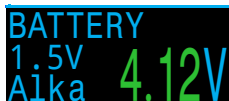

BATTERY
1.5V
Aika 4.12V

Current voltage of the internal battery. Displays in yellow when battery is low and needs to be replaced. Displays in red when battery is critically low and must be replaced immediately.

Clock



CLOCK
6:42

In a 12 or 24 hour format. Time format can be changed in the watch settings menu.

Date



DATE
03-Mar-20

In the format Day-Month Year.



3.8. Notifications

This section describes the different types of notifications the computer may present the diver.

See the [List of primary notifications on page 24](#) that a diver may encounter.

Color Coding

Color coding of text draws attention to problems or unsafe situations.

WHITE text indicates normal conditions by default.

Note that this normal condition color can be selected in the advanced configuration menu, described on [page 60](#).

YELLOW is used for warnings that are not immediately dangerous but should be addressed.



Sample warning - a better gas is available

FLASHING RED is used for critical warnings that could be life threatening if not immediately addressed.

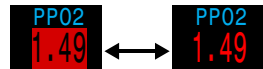

Sample critical warning - Continuing to breathe this gas could be fatal



Color blind users

The warning or critical warning states can be determined without the use of color.

Warnings display on a solid inverted background.

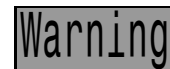

Doesn't flash

Critical Warnings flash between inverted and normal text.

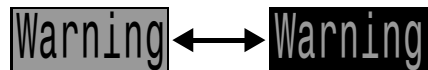

Flashes

Types of Notifications

Primary Notifications

Each of the primary notifications will display as a message in yellow across the bottom row until dismissed.



Sample Primary notification - High PPO2 Warning

The notification is dismissed by pressing either button.

For example, this “HIGH PPO2” message will appear if the average PPO2 goes above the PPO2 limit for more than 30 seconds.

The highest priority notification is listed first. If multiple errors occur simultaneously, the notification with the highest priority will be displayed. Clear the first notification by pressing a button to see the next one.

If vibration alerts are on, the unit will vibrate when the alert first occurs and every 10 seconds until it is acknowledged.

A list of primary notifications a diver may see is given on [page 24](#).



Persistent Notifications

Persistent notifications complement primary notifications. When the computer detects a dangerous situation, such as high PPO2, a warning is triggered. The large primary notification can be dismissed, but in most cases, a persistent notification will remain on the screen to the left of the NDL until the condition that caused the warning is resolved.

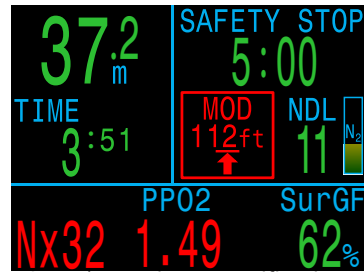

Sample Persistent Notification - MOD Exceeded

List of Persistent Notifications

High CNS

Central Nervous System (CNS) Oxygen Toxicity limit reached.

MOD, go up

Maximum Operating Depth (MOD) exceeded. Ascend to shown depth.

MOD, switch gas

Maximum Operating Depth (MOD) exceeded. Switch to more appropriate gas (another gas must be programmed and turned on for this to appear).

Near MOD

Within 5ft (1.9m) below MOD. Just a notification, no action required.

Better Gas

Another gas is programmed that is more suitable at the current depth. Only displays when deco stops are needed.

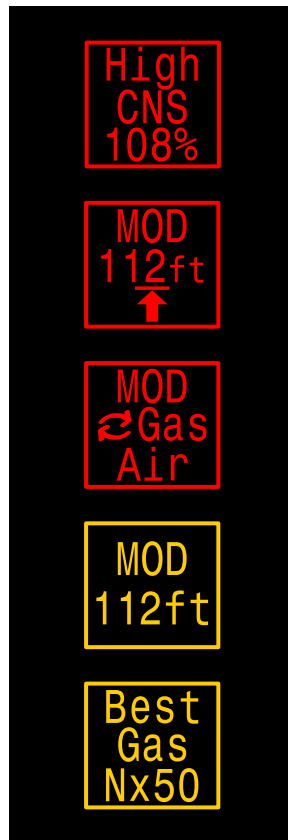

Vibration Alerts

In addition to visual notifications, the Petrel 3 has vibration alerts to help quickly notify the diver of warnings, errors and dive events.

If turned on, attention vibration alerts occur when a safety stop starts, pauses, or is completed. Vibration alerts will also occur any time a primary notification is triggered and every 10 seconds until it is acknowledged.

There are some persistent conditions, such as low PPO2 that will cause vibration to continue until the condition is resolved.

Vibration alerts can be toggled on or off in System Setup menu as described in the Alerts Setup section on page 57. Vibration alerts can also be toggled in the Dive Setup menu as described on page 48.

A Test Vibration tool is also available in the Dive Setup menu and should be used regularly before diving to ensure the vibrator is functioning properly.



Vibration is Battery Dependant

Vibration Alerts are only available when using a 1.5V Lithium or 3.7V Rechargeable Li-ion battery.



Caution

Although vibration alerts are very useful, never rely on them for your safety. Electromechanical devices can and will eventually fail.

Always be proactively aware of your depth, no-decompression limit, gas supply, and other critical dive data. You are ultimately responsible for your own safety.



3.9. Customizable Alerts

In addition to automatic warnings indicating potentially dangerous situations, the Petrel 3 has customizable alerts for maximum depth, maximum dive time, and minimum no-decompression limit.

See on Alerts Setup on page 57 for details on how to modify these alerts.

Depth Alert

By default the depth alert is set to 40 meters.

In addition to the Primary notification which can be dismissed, the depth value will turn yellow when deeper than the Alert value.



The depth alert will reset if the depth goes 2m shallower than the alert depth.

Time Alert

By default the dive time alert is set to 60 minutes, but is turned off.

In addition to the Primary notification which can be dismissed, the dive time value will turn yellow when greater than the Alert value.



The time alert will only fire once per dive.

Low NDL Alert

By default the low NDL alert is set to 5 minutes.

In addition to the Primary notification which can be dismissed, the NDL value will turn yellow when at or below the Alert value.



The NDL alert will reset if the NDL goes above the NDL alert value by 3 minutes.

Example: If NDL Alert value is 5 minutes, The NDL Alert will reset once NDL reaches 8 minutes.



Limitations of Alarms

All alarm systems share common weaknesses.

They can alarm when no error condition exists (false positive). Or they can fail to alarm when a real error condition occurs (false negative).

Respond to alarms if you see them, but NEVER depend on them. Your judgment, education, and experience are your best defenses. Have a plan for failures, build experience slowly, and dive within your experience.



3.10. List of primary notifications

The following table lists primary notifications you may see, their meaning, and steps to take to solve any problems.

If multiple warnings are triggered simultaneously, the notification with the highest priority will be displayed. Clear that notification by pressing any button to see the next notification.

Contact Shearwater

The subsequent list of notifications is not exhaustive. Please contact Shearwater if you experience any unexpected errors: info@shearwater.com

Display	Meaning	Action to take
	The PPO2 is below the limit set in the PPO2 limits menu.	Change your breathing gas to one safe for the current depth.
	The PPO2 is above the limit set in the PPO2 limits menu.	Change your breathing gas to one safe for the current depth.
	A required decompression stop was violated.	Descend deeper than the currently displayed stop depth. Monitor for symptoms of DCS. Use extra conservatism for future repetitive dives.
	The ascent was sustained as faster than 10m/min (33ft/min)	Use a slow ascent rate. Monitor for symptoms of DCS. Use extra conservatism for future repetitive dives.

Display	Meaning	Action to take
	The internal battery is low.	Replace the battery.
	The decompression tissue inert gas loading has been set to default levels.	Plan repetitive dives accordingly.
	Central Nervous System (CNS) toxicity clock exceeded 150%	Switch to a gas with a lower PPO2 or ascend shallower (decompression ceiling allowing)
	Central Nervous System (CNS) toxicity clock exceeded 90%	Switch to a gas with a lower PPO2 or ascend shallower (decompression ceiling allowing)
	NDL is less than low NDL alert value. (Only if alert active)	Ascend soon to avoid decompression obligation.
	Depth is deeper than depth alert value. (Only if alert active)	Ascend above depth limit.
	Dive time has surpassed time alert value. (Only if alert active)	End dive safely.
	No communications for 30 to 90 seconds.	See the Transmitter Connection Issues section on page 45 for more information.
	No communications for 90+ seconds.	See the Transmitter Connection Issues section on page 45 for more information.



Display	Meaning	Action to take
	<p>Low transmitter battery.</p>	<p>Replace the transmitter battery.</p>
	<p>Tank pressure exceeds rated pressure by more than 10%</p>	<p>Properly set the rated pressure in the AI Setup menu. See details on page 55.</p>
	<p>Tank pressure has fallen below the critical pressure.</p>	<p>Be aware that gas is running low. Begin to end your dive and perform a controlled ascent to the surface.</p>
	<p>GTR is not available when on the surface.</p>	<p>None. GTR will display during a dive.</p>
	<p>GTR is not ready.</p>	<p>None. After a few minutes, enough data has been collected for display.</p>
	<p>The computer has reset to recover from an unexpected software condition.</p>	<p>If this occurs more than once over a long period, please report to Shearwater Research Inc.</p>
	<p>This reset shows up after a software update. This is the normal event that shows the computer has been rebooted after the software update.</p>	<p>N/A</p>
	<p>Firmware update failed, possibly due to a communications error or corrupted file.</p>	<p>Try the firmware upgrade again. Contact Shearwater if problem persists.</p>



4. Safety and Decompression Stops

Safety and decompression stops are pauses inserted into the ascent to the surface in order to reduce the risk of decompression illness (DCI).

4.1. Safety Stops

A safety stop is an optional stop added to all dives before surfacing. Safety stops can be set to fixed times of 3, 4, or 5 minutes, set to adapt based on dive conditions, or turned off completely. See [Deco Setup](#) on page 54 for more info.

The Petrel 3 does not do “deep safety stops”. That is, there are no extra stops added around 15m to 18m (50ft to 60ft) when ascending from a no-deco dive.

Safety stops behave as follows:

Safety Stop Required

Once the depth exceeds 11m (35ft), a safety stop counter will appear in the top right corner of the display.



Automatic Countdown

Countdown begins once the depth becomes shallower than 6m (20ft). Countdown will continue while the depth remains in the range of 2.4m to 8.3m (7ft to 27ft).



Countdown Paused

If the depth goes outside of the range 2.4m to 8.3m (7ft to 27ft), then the countdown pauses, and the remaining time displays in yellow.



Safety Stop Complete

When the countdown reaches zero, the display changes to “Complete” and you are now clear to ascend to the surface.



Countdown Reset

The countdown will reset if the depth once again exceeds 11m (35ft).



No Lockout for omitting

There is no lock-out or other penalty for omitting a safety stop, as they are optional.

If you ascend to the surface before the safety stop countdown finishes, the safety stop will appear paused, but this will disappear once the dive ends.

We recommend performing safety stops as planned as they offer a reduction in risk of DCI and take little time.

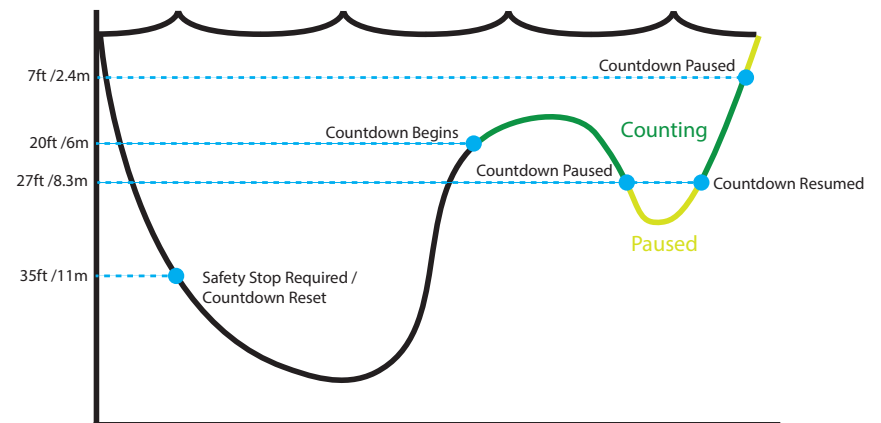

Safety Stop Thresholds - Not to scale



4.2. Decompression Stops

Decompression stops are mandatory stops that must be followed in order to reduce the risk of decompression illness (DCI).



Do not dive beyond your training

Only perform decompression diving if you have received proper training to do so.

Diving with any type of overhead ceiling, whether in a cave or shipwreck, or from a decompression requirement, adds significant risk. Have a plan to handle failures and never rely solely on a single source of information.

Decompression stops occur at fixed 3m (10ft) intervals.

Decompression stops display as follows:

Replaces Safety Stop

Once the NDL reaches zero, deco stop information will replace safety stop display.

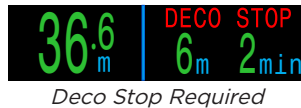

Approach Indicator

As you approach within 17ft (5.1m) of the first decompression stop, the title will change from red to yellow and a flashing up-arrow will indicate to ascend to the stop.



At Deco Stop

While at the stop depth or up to 5ft (1.5m) deeper, the title will turn green and a check mark will be shown. Hold this depth until stop time clears.



Deco Stop Violation

If you ascend shallower than a deco stop, the display will **flash red**. Significant stop violations will result in a “MISSED STOP” notification.



Deco Stops Complete

Once all decompression stops are complete, the safety stop will begin counting down.



If enabled, the Deco Clear counter will begin counting up from zero.

If safety stops and deco clear counter are disabled “Complete” will appear across the deco stop information area.



No Lockout for violating Deco Stops

There is no lock-out or other penalty for violating decompression stops.

The policy is to provide clear warnings that the decompression scheduled was violated, to allow you to make decisions based on your training.

This may include contacting your dive insurance provider, contacting the nearest recompression chamber, or performing first aid based on your training.



5. Decompression and Gradient Factors

The basic decompression algorithm used by this computer is Bühlmann ZHL-16C. It has been modified by the use of Gradient Factors that were developed by Erik Baker. We have used his ideas to create our own code to implement it. We would like to give credit to Erik for his work in education about decompression algorithms, but he is in no way responsible for the code we have written.

The computer implements Gradient Factors creating varied levels of conservatism. The levels of conservatism are pairs of numbers like 30/70. For a more detailed explanation of their meaning, please refer to Erik Baker's excellent articles: "Clearing Up The Confusion About Deep Stops" and "Understanding M-values". The articles are readily available on the web. You might also want to search for "Gradient Factors" on the web.

The default conservatism of the system in all dive modes is medium (40/85).

The system provides settings that are more aggressive and more conservative than the default.

Do not edit GF values until you understand the effects.

Graph from Erik Baker's "Clearing Up The Confusion About Deep Stops"
Pressure Graph: Gradient Factors

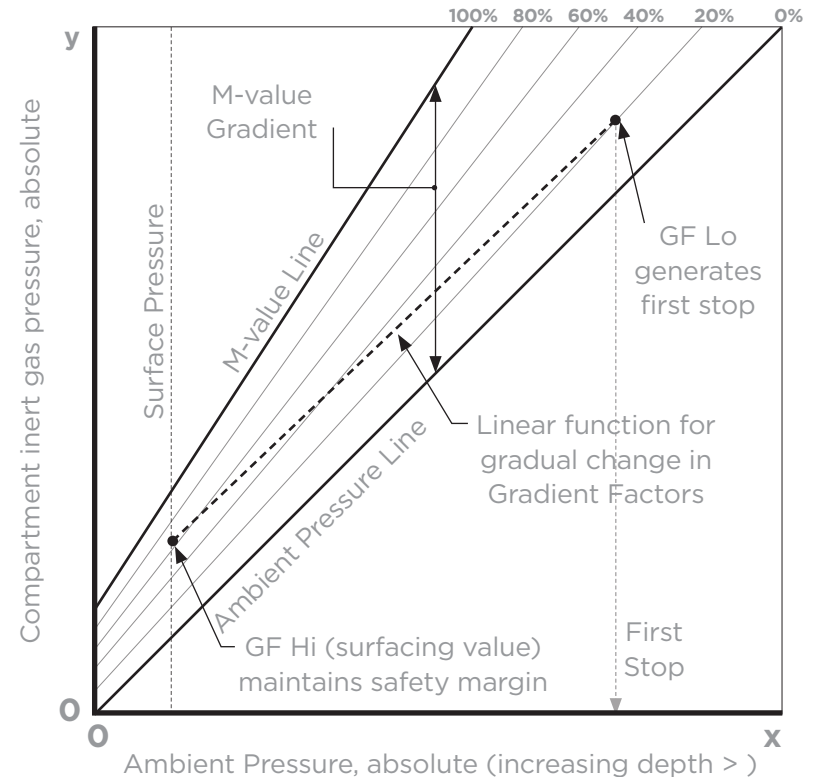

- A Gradient Factor is simply a decimal fraction (or percentage) of the M-value Gradient.
- Gradient Factors (GF) are defined from 0% to 100%.
- A Gradient Factor of 0% represents the ambient pressure line.
- A Gradient Factor of 100% represents the M-value line.
- Gradient Factors modify the original M-value equations for conservatism within the decompression zone.
- The lower Gradient Factor value (GF Lo) determines the depth of the first stop. Used to generate deep stops to the depth of the "deepest possible deco stop"
- The higher Gradient Factor value (GF Hi) determines the surfacing tissue supersaturation.



5.1. Decompression Information Accuracy

Decompression information displayed by this computer, including NDL, stop depth, stop time, and TTS are predictions. These values are continuously recalculated and will change with changing conditions. The accuracy of these predictions is dependent on several assumptions made by the decompression algorithm. It is important to understand these assumptions to ensure accurate decompression predictions.

It is assumed that the diver's ascent rate is 10m/min (33ft/min). Ascending significantly faster or slower than this will impact decompression obligations. It is also assumed that the diver is carrying and plans to use every gas that is currently turned on. Leaving gases that are not expected to be used turned on will result in inaccurate time to surface, decompression stop and decompression time information being displayed.

On ascent, it is assumed that the diver will perform decompression stops using the gas with the highest PPO₂ below the OC Deco PPO₂ value (default 1.61). If there is a better gas available, the current gas will be displayed in yellow, indicating that a gas change is expected. The decompression prediction displayed always assumes that the best gas will be used. Even if the switch to a better gas has not been completed yet, decompression predictions will be displayed as if the switch is about to occur in the next 5 seconds.

Divers can encounter longer than expected decompression stops as well as inaccurate time to surface predictions if they fail to switch to a better gas when prompted by the computer.

Example: A diver on a decompression dive to 40m/131ft for 40 minutes with GF settings of 45/85 has two gases programmed into their computer and turned on: 21% O₂ & 99% O₂. The diver's decompression schedule will be calculated based on breathing 21% oxygen for the descent, bottom and ascent phases of the dive until the diver ascends to 6m/20ft. At 6m/20ft the PPO₂ of the 99% O₂ mix is 1.606 (less than 1.61), so it is the best decompression gas available.

Decompression information for the remaining stops will be calculated and displayed assuming the diver is going to switch to this better gas. This dive profile indicates these stops would be 8 minutes at 6m/20ft and 12 minutes at 3m/10ft. If the diver never makes the switch to 99% O₂, the computer will not allow them to surface until adequate off-gassing has occurred, but it will continue to assume the diver is about to make the gas switch and the decompression times given will be grossly inaccurate. The 6m/20ft stop will take 19 minutes to clear and the 3m/10ft stop will take 38 minutes to clear. That is a total time to surface difference of 37 minutes.

In a lost gas scenario or in the event a diver forgets to turn off a gas they are not carrying before a dive, gases can be turned off during the dive in Dive Setup -> Define Gases.



6. Example Dives

6.1. Single Gas Example Dive

This is an example of displays that might be seen on a simple no-decompression dive in a single gas mode (Air or Nitrox).

1. Pre-Dive - This is the surface screen immediately before descending. At the surface, the battery is shown to be about 75% full. Air is the selected breathing gas. Maximum depth from the previous dive is displayed.

2. Descent - As we pass through 11 meters, NDL shows 99 minutes, the maximum no decompression limit that the computer will display during a dive. At this depth the safety stop counter will appear.

3. Max Depth - The NDL starts to show smaller numbers as depth increases. The 3rd screen shows that we will go into deco in 8 minutes. The safety stop counter has automatically increased to 5 minutes because the computer knows this is a deep dive.

4. Low NDL - When the NDL goes below 5 minutes, it turns yellow indicating that we should begin making our ascent to avoid a decompression obligation.

5. Ascent - As we ascend our NDL begins increasing again, indicating that we can stay a bit longer at this shallower depth. The ascent rate indicator shows that we are ascending at about 6 mpm or 22 fpm.

6. Safety Stop - When we ascend shallower than 6m, the safety stop counter will begin counting down. In this case the safety stop setting has been set to Adapt, and because of our deep profile, the countdown began at 5 minutes. A “Complete” indicator will inform us when the safety stop has been completed.

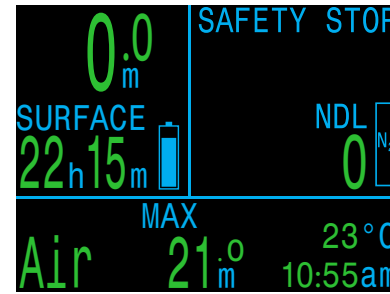

1. Pre-Dive



2. Descent



3. Max Depth



4. Low NDL



5. Ascent



6. Safety Stop



Although safety stops are not mandatory, when gas supplies permit, the best practice is to perform a safety stop on every dive.



6.2. Multi-Gas Example Dive

This is an example of displays that might be seen on a multi-gas decompression dive in 3GasNX Mode.

Max Depth: 40 meters	Bottom Gas: 28% O ₂
Bottom Time: 20 minutes	Deco Gas: 50% O ₂

1. Gas Setup - Best practices include checking your gas list before each dive. This screen is available in the Nitrox Gases section of the System Setup menu. All gases that are turned on will be used to calculate the decompression schedule. Turn off gases you are not carrying. Note that the MOD displayed on this screen will only impact the bottom gas (28% O₂). Deco gases are governed by Deco PPO₂.

2. Verify Decompression Settings - It is also prudent to ensure all other settings are correct before starting every dive. In addition to checking gases, we recommend verifying values in the Deco Setup menu.

3. Plan Dive - Use the decompression planner found in Dive Setup to check the total runtime, decompression scheduled and gas requirements for the dive with current settings.

The on-board deco planner is limited in functionality, so for complex dives we recommend using desktop or smartphone dive planning software.

4. Pre-Dive - Prior to beginning the dive we can see the active gas is currently set to 28% Nitrox and our battery is about three quarters charged.

5. Descent - As we descend our dive time begins counting and our NDL changes from zero to 99.

Nitrox Gases			
#	On	O ₂ %	MOD
▶ 1	Off	99%	6.3m
2	On	50%	23m
A3	On	28%	57m
MOD PPO ₂			1.4
Next			Edit

1. Gas Setup

Deco Setup	
Buhlmann GF ZHL-16C	
Conservatism Custom	
GF	30/70
Last Stop	3m
Safety Stop	CntUp
Next	Edit

2. Verify Deco Settings

OC	Depth	Time	RMV
	040	020	15
Stp	Tme	Run	Gas Qty
40	bot	20	28% 1419
21	asc	22	28% 115
12	asc	23	50% 36
12	1	24	50% 33
9	1	25	50% 29
Quit			Next

3. Plan Dive - Deco Scheduled

OC	Depth	Time	RMV
	040	020	15
Gas Usage, in Liters			
50%: 287			
28%: 1534			
Quit			Next

3. Plan Dive - Gas Requirement

SAFETY STOP	
0.0 m	NDL 0
SURFACE	N ₂
45h 11m	
MAX	
Nx28	38.8 m
	23°C
	9:22am

4. Pre-Dive

SAFETY STOP	
11.0 m	NDL 99
TIME	N ₂
1:35	
MAX	
Nx28	11.0 m
	21°C
	9:24am

5. Descent

(Continued on next page)



Multi-Gas Example Dive (cont.)

6. Max depth - Once NDL hits 0, deco stops will be needed. Stop requirements display in place of the Safety Stop information.

7. Ascent - It is safe to ascend to 12 meters. 1 minute must be spent at that deco stop. While ascending, the bar graph to the right of the depth shows the ascent rate. Two chevrons indicate an ascent rate of 6 mpm in this example. All decompression predictions are made assuming an ascent rate of 10 meters per minute.

8. Gas Change - All decompression predictions are made assuming you will switch to the best available gas on ascent. At 21m, the breathing gas turns yellow indicating that a better breathing gas is available. If the switch is not made, deco stop and time information will be inaccurate.

9. Approaching Deco Stop - As you ascend, the computer will notify you of an approaching deco stop. A green check will appear when within 1.8m deeper than the deco stop depth.

10. Missed Deco Stop - If you ascend shallower than the decompression ceiling the Deco information will flash red. If you fail to descend, a missed deco stop warning will be triggered. Acknowledge and clear the primary notification by pressing any button. Re-descend deeper than the stop depth to clear the flashing text.

10. Deco Clear - Once all decompression obligation has been cleared, the safety stop will begin if active. In this case deco clear counter begins counting up from zero.

End of example.

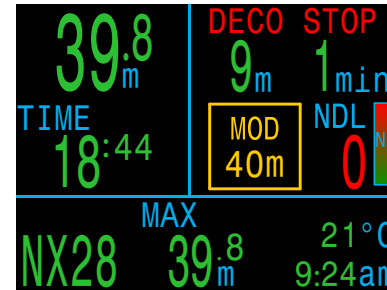

6. Max Depth

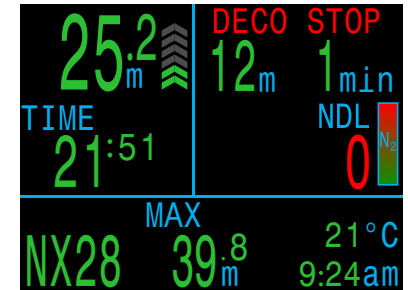

7. Ascent

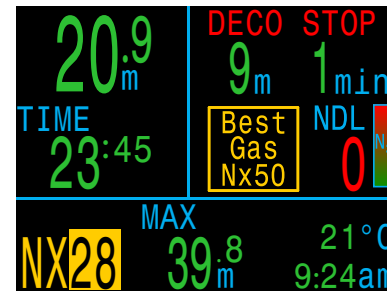

8. Gas Change

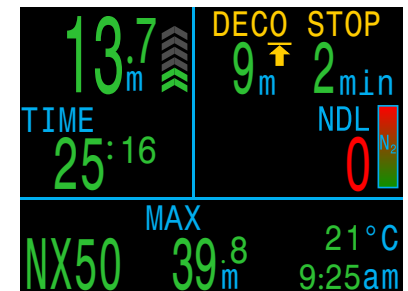

9. Approaching Deco Stop



10. Missed Deco Stop

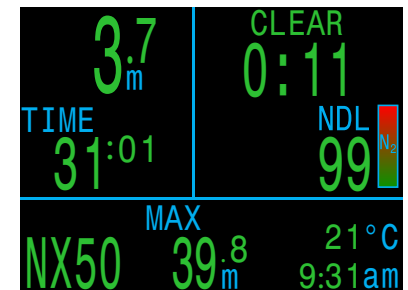

11. Deco Clear



7. Gauge Mode

Gauge Mode turns the Petrel 3 into a simple depth and time display (a.k.a. a bottom timer).

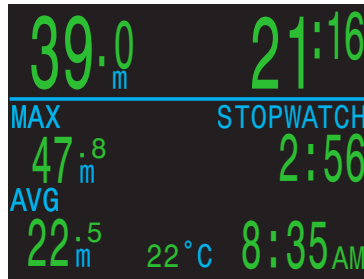

Gauge Mode

Since decompression tissues are not tracked in Gauge Mode, changing to or from Gauge Mode resets the deco tissues.

Change to Gauge Mode in the System Setup > Mode Setup menu. [page 53](#).

Gauge Mode Features:

- Extra-large depth display (meters or feet)
- Extra-large time display (in minutes:seconds)
- Maximum and average depth on main screen.
- Resettable average depth
- Stopwatch

The Gauge Display is organized by:

- Depths along the left.
- Times along the right.
- Depth and Dive Time in the top row.

Stopwatch

When diving, starting or stopping the Stopwatch is the first menu option.

When stopped, the word “Stopwatch” displays in red.

When non-zero, the stopwatch can be reset. Reset behavior depends on state:

- If running when reset, it continues running, counting up again from 0.
- If stopped when reset, then it is set 0 and remains stopped.

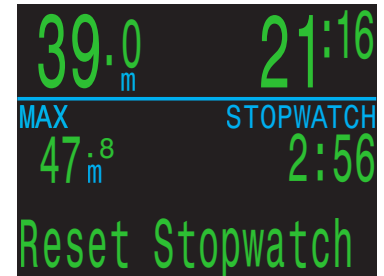
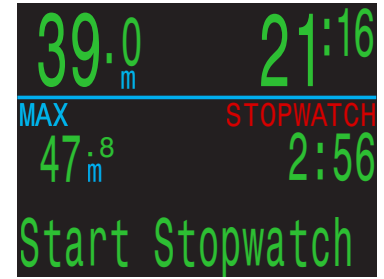

Resettable Average Depth

During a dive, the average depth can be reset.

While on the surface, the MAX and AVG values display the maximum and average depth of the last dive. The AVG depth displayed on the surface is for the entire dive, regardless of whether the reset average depth option was used. The dive log also records the average depth for the entire dive.



8. Compass

The Petrel 3 contains a tilt-compensated digital compass.

Compass Features

- 1° resolution
- ±5° accuracy
- High-speed refresh rate
- User set heading marker with reciprocal
- True North (declination) adjustment
- Tilt compensation ±45°



Viewing the Compass

When enabled, the compass is viewed by pressing the SELECT (right) button once. Press SELECT again to continue on to view the regular info screens.

Unlike the regular info screens, the compass never times out back to the main screen. Press MENU (left) button to return to the main screen.

Marking a Heading

To mark a heading, when viewing the compass press the MENU (left) button. This brings up the “Exit/Mark” menu. Press the SELECT (right) button to mark the heading.



The marked heading is shown with a green arrow. When within 35° of the heading, the degrees display turns green.



The reciprocal heading (180° from marked heading) is shown with a red arrow. When within 35° of the reciprocal heading, the degrees display turns red.



When more than 5° off the marked heading, a green arrow shows the direction back to the marked heading.



Also, the offset degrees to the heading are displayed (16° in the example image). This offset is useful when navigating patterns. For example, a box pattern requires turns at 90° intervals, while a triangle pattern requires 120° turns.

Compass Limitations

Calibration - The digital compass needs occasional calibration. This can be done in the **System Setup** → **Compass** menu. [See details on page 58.](#)

Battery Changes - When the battery is changed, the compass requires calibration.

Interference - Since a compass operates by reading the Earth’s magnetic field, the compass heading is affected by anything that distorts that field or creates its own. Steel objects and electric motors or cabling (e.g. from dive lights) should be kept at a distance. Being close to or inside a shipwreck may also affect the compass.

Magnetic declination (also called magnetic variation) is the difference between magnetic and True North. This can be compensated in the Compass Setup menu using the True North setting. The magnetic declination varies around the world, so will need to be readjusted when traveling.

Magnetic inclination (or magnetic dip) is how much the Earth’s magnetic field points up or down. The compass automatically compensates for this angle. However, near the poles, the inclination angle can exceed 80° (i.e. the magnetic field points almost directly up or down), in which case the specified accuracy may not be met.



9. Air Integration (AI)

The Petrel 3 is equipped with 4-transmitter air integration capability.

This section covers operation of the AI feature.

AI Features

- Simultaneous wireless pressure monitoring of up to 4 tanks.
- Units in psi or bar.
- Gas Time Remaining (GTR) and Surface Air Consumption (SAC) rate based on one tank.
- Sidemount support for SAC, GTR, and Redundant Time Remaining (RTR)
- Sidemount Tank Switch Notifications
- Logging of pressure, GTR and SAC
- Reserve and critical gas pressure warnings.

9.1. What is AI?

AI stands for Air Integration. On the Petrel 3, this refers to a system that uses wireless transmitters to measure the gas pressure in a SCUBA tank and transmit this information to the Petrel 3 dive computer for display and logging.

Data is transmitted using low-frequency (38kHz) radio frequency communications. A receiver in the Petrel 3 accepts this data and formats it for display.

The communication is one-way. The transmitter sends data to the Petrel 3, but the dive computer does not send any data to the transmitter.



Shearwater Swift Wireless Transmitter



Use a backup analog SPG

Always use a backup analog submersible pressure gauge as a redundant source of gas pressure information.

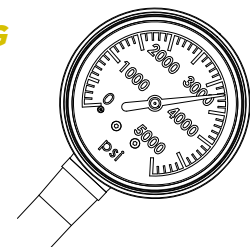



9.2. Basic AI Setup

This section will get you started with the basics of AI on the Petrel 3. Advanced setup and detailed descriptions will be covered in later sections.

Install the Transmitter

Before using the AI system, you will need to install one or more transmitters on a scuba tank first stage regulator.

The transmitter must be installed on a first stage port labeled “HP” (high pressure). Use a first stage regulator with at least two HP ports, so that a backup analog submersible pressure gauge (SPG) can be used.

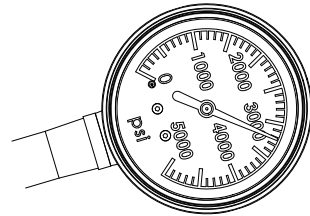

A backup SPG is recommended

Position the transmitter such that it is on the same side of your body as you wear your Petrel 3 handset. Range is limited to approximately 1 m (3 ft).

A high-pressure hose may be used to relocate the transmitter for better reception or convenience. Use hoses rated for a working pressure of 300 bar (4500 psi) or higher.



Some transmitters require a wrench (11/16” or 17mm) to tighten or loosen

Avoid hand tightening or loosening unless otherwise specified by the transmitter manufacturer, as this may damage the transmitter.



The Shearwater Swift transmitter can be installed without tools.

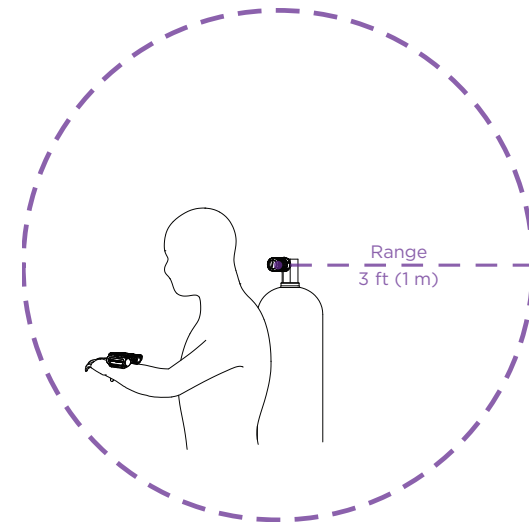
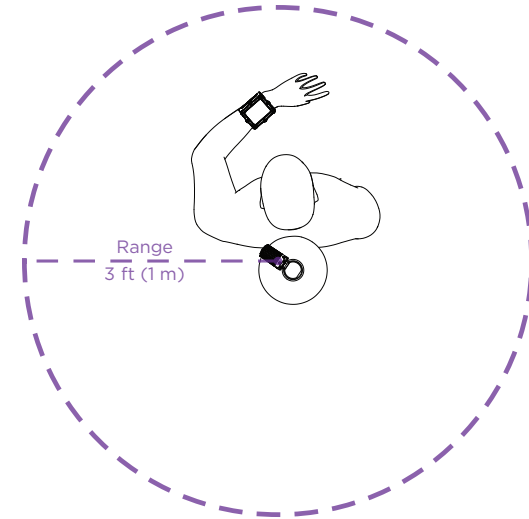

Install transmitter on 1st stage HP port

Install transmitter on the same side of your body as the handset. Range is approximately 3 feet (1 m).



Turn on the Transmitter

Turn on the transmitter by opening the tank valve. The transmitter will automatically wake up when it detects pressure.

Pressure data is transmitted approximately every 5 seconds.

Turn off the Transmitter

To turn off the transmitter, close the tank valve and purge the second stage regulator to drain pressure from the hoses. The transmitter will automatically power down after 2 minutes of no applied pressure.

Enable AI on the Petrel 3

On the Petrel 3, navigate to the **System Setup > AI Setup**. Change the **AI Mode** setting to **On**.



When **AI Mode** is set to **Off**, the AI sub-system is completely powered down and does not consume any power. When on, the AI system increases power consumption by approximately 10%.

Note that AI is never on when the Petrel 3 is turned off.

More information can be found in the [the AI Setup section on page 55](#).

Pair the Transmitter

Each transmitter has a unique serial number etched on its body. All communications are coded with this number so that the source of each pressure reading can be identified.



Pair the transmitter by going to the **Tx Setup** menu option, and selecting T1. Turn on T1, then enter the 6-digit transmitter serial number into the **T1 Serial #** setting. You only need to set this once, as it will be permanently saved in the settings memory.

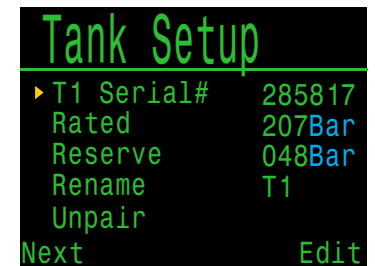
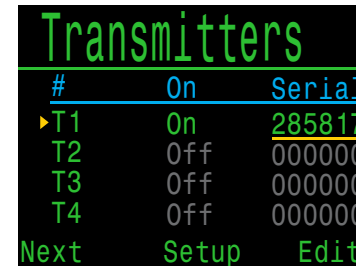



Add an AI display to the home screen

AI information is automatically displayed as an info screen when the AI feature is enabled, however, the main screen will not show AI information until manually added.

In recreational diving modes, add AI to the home screen in the System Setup > Bottom Row menu.

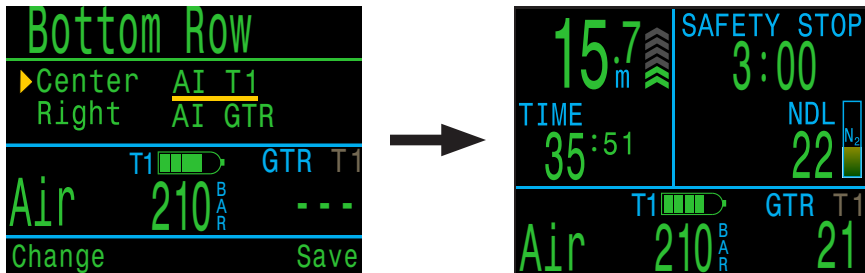

The center row can be customized extensively to show a wide variety of information.

Find more information about how to do this in [the Bottom Row section on page 57](#).



Check that your tank valve is open

Always take a few breaths from your regulator or purge your regulator's second stage while monitoring your tank pressure for a full 10-15 seconds prior to entering the water to ensure your tank valve is turned on.

If the first stage regulator is charged but the tank valve has been closed, the breathing gas available to the diver will decrease rapidly and within a few breaths the diver will face an "out of air" situation. Unlike an analog gauge, the air pressure reported on the Petrel 3 will only update every 5 seconds, so the pressure reported by the Petrel 3 must be monitored for longer than that (we suggest 10-15 seconds) to ensure the tank valve is open.

Including a regulator purge test followed by 10-15 seconds of air pressure monitoring before entering the water as part of your pre-dive safety check is a good way to mitigate this risk.



9.3. AI Displays

This section describes the display field types that are used to display AI information. The display types are:

- 1) Tank Pressure
- 2) SAC
- 3) GTR
- 4) RTR (sidemount only)
- 5) AI combination display

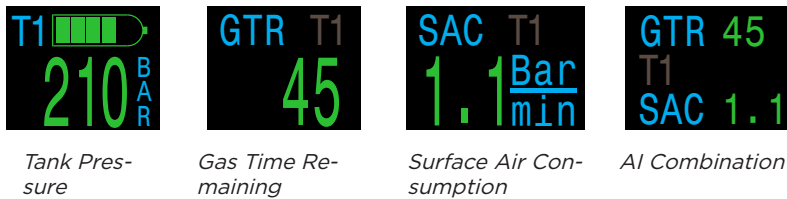

These displays can be viewed in two ways:

- 1) Added to a customizable zone on the home screen
- 2) Most can be viewed on the AI info screen.

Renaming Transmitters

Transmitter titles can be customized in the transmitter setup menu. This makes it easier to keep track of which transmitter is reporting which cylinder pressure.

Each transmitter title has 2 characters that apply to all AI displays. The following options are available.

- First Character: T, S, B, O, or D
 Second Character: 1, 2, 3, or 4



Renaming is for display purposes only. There is no relationship between a transmitter title and gas fraction for decompression calculation purposes.

Tank Pressure Display

The pressure displays are the most fundamental AI displays, showing pressure in the current units (psi or bar).

At the top of each pressure display, a bar graph represents the pressure graphically. This bar graph is scaled from zero pressure up to the **rated pressure** setting. This is NOT a battery level indicator.

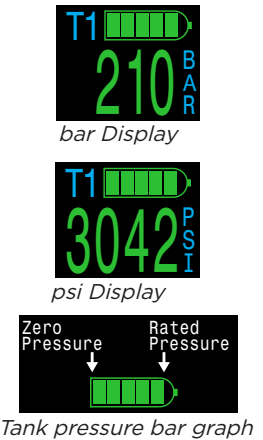

Low Pressure warnings:



Reserve Pressure thresholds can be managed in the AI Setup Menu. [See details on page 56.](#)

No Communication Warnings:

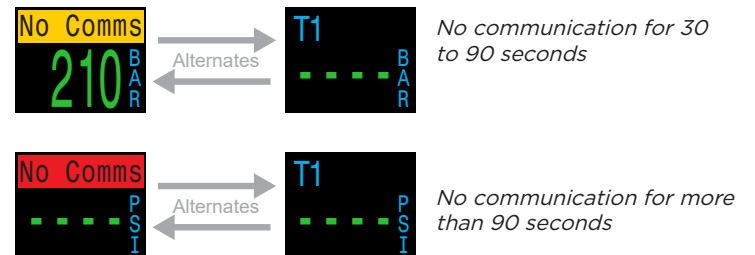

Low Transmitter Battery Warnings:

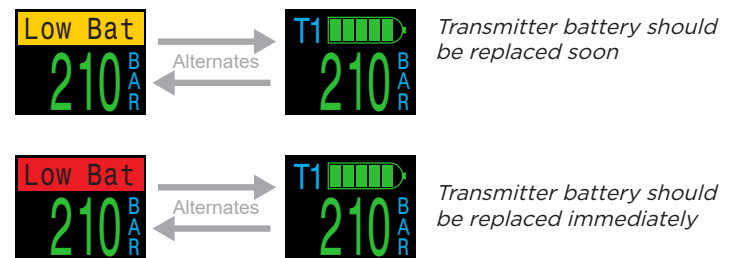



SAC Display

The Surface Air Consumption (SAC) display shows the average rate of pressure change over the last two minutes, normalized to as if at 1 ATA pressure. Depending on the current units setting, SAC is either displayed in psi/minute or bar/minute.

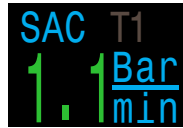

SAC can be displayed for a single tank, or for a sidemount configuration of two tanks of identical volume.

i Note that SAC in pressure per minute is NOT transferable between tanks of different sizes.

The title indicates which transmitter is being used for the SAC calculations in a dark gray font. “SM” indicates that Sidemount SAC is selected.

The tank(s) included in the SAC calculation are selected in the AI Setup menu ([page 55](#)).

During the first few minutes of a dive the SAC value is not available, while the initial data is being collected for averaging calculations. The SAC display will show “wait” during this time.

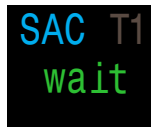

i **On surface, SAC is average from last dive**

The average SAC from your last dive is shown when on the surface. When a dive ends, you may notice the SAC value suddenly changes. This is because the SAC display changes from showing the SAC over the last two minutes (when in dive mode) to showing the average SAC for the whole dive.

GTR Display

The Gas Time Remaining display shows the time, in minutes, that you could stay at the current depth until a direct ascent to the surface at a speed of 33 feet/min (10 m/min) would result in surfacing with the reserve gas pressure remaining.



The Value is displayed in yellow when less than or equal to 5 minutes. The value is displayed in red when less than or equal to 2 minutes.

GTR can only be based on a single tank or when sidemount is selected, with 2 tanks of identical volume.

The title indicates which transmitter is being used for the GTR calculations in a dark gray font. “SM” indicates that Sidemount GTR is selected.

When on the surface, the GTR displays “---”. **GTR is not shown when decompression stops are needed, and will display “deco”.**

SAC data from the first 30 seconds of each dive is discarded. It then takes an additional few minutes to calculate the average SAC. Therefore, for the first few minutes of each dive, the GTR will display “wait”, until enough data has been collected to begin making GTR predictions.

More information on how GTR is calculated can be found in the [the GTR calculations section on page 44](#).

No GTR
on surface



At start of dive,
wait for data to
stabilize



RTR Display (Sidemount Only)

The Redundant Time Remaining (RTR) display indicates how much gas time remains if calculated only using the pressure of the sidemount tank with less pressure (i.e. all gas in the higher pressure tank was lost).



All of the same rules apply to RTR as they do to GTR and it is calculated in exactly the same way.

The title indicates the tank that is currently being used for the RTR calculation in dark grey.

AI Combination Displays

AI combination displays automatically populate the AI info row to pack more information into the limited available space. The format of the AI combinations is based on AI settings. Some examples are given below. This is not an exhaustive list of the possible displays.

See the bottom row menu section on [page 57](#) to learn how to place AI displays on your home screen.

AI Setting	Display
Tx Setup T1 GTR Mode T1	T1 [Bar] GTR T1 SAC T1 210 BAR 45 1.1 Bar/min
Tx Setup T1 T2 GTR Mode SM:T1+T2	T1 [Bar] GTR 45 T2 [Bar] 210 BAR SM SAC 1.1 207 B
Tx Setup T1 T2 T3 T4 GTR Mode SM:T1+T2	T1 210 GTR 45 T3 198 T2 207 SM SAC 1.1 T4 180

9.4. Sidemount AI

The Petrel 3 offers some features that make gas tracking more convenient while sidemount diving. These include:

- Sidemount tank switch notifications
- Sidemount SAC calculations
- Sidemount GTR and RTR

All sidemount features are enabled in the AI setup menu by setting the GTR Mode option to the desired SM combination.

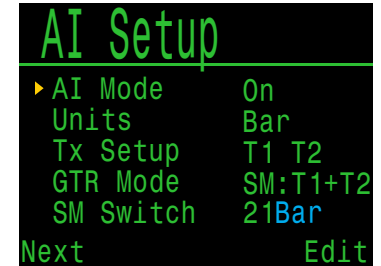

Use Identical Tanks For Sidemount

Sidemount features were designed assuming the sidemount tanks are of identical volume. This removes the need to enter tank volumes into the computer, simplifying the user interface and reducing the chances of input errors.

Do not use sidemount AI features with tanks of differing volumes.

Sidemount Tank Switch Notifications

When the sidemount feature is enabled switch notifications will appear as a green box highlighting the label of the tank you should be breathing from. This provides a subtle reminder to switch tanks when the difference between tank pressures rises above the SM Switch setting.



The switch notification setting has a range of 7 bar - 69 bar or 100 psi - 999 psi.



Sidemount SAC and GTR

Sidemount SAC and GTR are calculated the same way as single tank SAC and GTR except the tank pressures are pooled prior to each calculation. Essentially the two tanks are treated as one large tank.

Sidemount SAC and GTR calculations are dependent on the assumption that both sidemount tanks are of identical volume.

Note that SAC rate is not transferable between tanks of differing volumes. You must convert SAC to RMV for comparing gas consumption across different tank configurations.

For the purposes of RMV calculations using sidemount SAC, follow the same procedure outlined for a single tank in [the SAC calculations section on page 43](#), but add all of the relevant tank attributes together as if you were using a single large tank.

Total volume = Volume_{Tank 1} + Volume_{Tank 2}

Total rated pressure = Rated pressure_{Tank 1} + Rated pressure_{Tank 2}

9.5. Using Multiple Transmitters

When using multiple transmitters, best reception reliability will be attained by using transmitters with different transmission intervals or by using transmitters with active collision avoidance such as the Shearwater Swift Transmitter.

When two transmitters of the same transmission interval are used, the potential exists for their communication timing to become synchronized. When this occurs, data dropouts may result and could last up to 20 minutes or more.

Legacy Shearwater transmitters of different colors have different transmit timing. This reduces communication collisions that could potentially cause a loss of connection.

When using more than two transmitters, Shearwater recommends using the Swift transmitter which actively 'listens' for other transmitters in the vicinity and dynamically alters transmit timing to avoid interference.

There is no defined upper limit to the number of Swift transmitters that can be run concurrently. For more details, see the Swift Operating Instructions Manual.



Using Multiple Transmitters With The Same Transmission Interval May Result in Lost Comms

When using more than one transmitter, use transmitters with adaptive collision avoidance or legacy transmitters of different colors to prevent interference (see above).



9.6. SAC calculations

Surface Air Consumption (SAC) is the **rate of change of tank pressure**, normalized as if at 1 atmosphere of pressure. The units are either psi/minute or bar/minute.

The Petrel 3 calculates SAC averaged over the last two minutes. The data from the first 30 seconds of a dive are discarded to ignore the extra gas that is typically used during this time (inflating BCD, wing, or dry suit).

SAC vs RMV

Since SAC is simply based on rate of tank pressure change, the calculations do not need to know the tank size. However, this means that the SAC is NOT transferable to tanks of a different size.

Contrast this to respiratory minute volume (RMV) which is the volume of gas your lungs experience per minute, measured in Cuft/min or L/min. The RMV describes your personal breathing rate, and is therefore independent of tank size.

Why SAC instead of RMV?

Since RMV has the desirable property of being transferable between tanks of different sizes, it seems to be the better choice on which to base GTR calculations. However, the main drawback of using RMV is that it requires setting up tank size correctly for each tank. Such setup is easy to forget and is also easy to setup incorrectly.

SAC has the great property of not requiring any setup, making it the simplest and most reliable choice. The drawback is that it is not transferable between tanks of different sizes.

SAC Formula

The SAC is calculated as follows:

$$SAC = \frac{P_{tank}(t_1) - P_{tank}(t_2)}{t_2 - t_1} / P_{amb,ATA}$$

$P_{tank}(t)$ = Tank pressure at time t [PSI] or [Bar]
 t = Time [minutes]
 $P_{amb,ATA}$ = Ambient pressure [ATA]

The time samples are taken 2 minutes apart, and $P_{amb,ATA}$ is the average ambient pressure (i.e. depth) over this time frame.

Since the Petrel 3 displays and logs SAC, the formula for calculating RMV from SAC is useful. Knowing your RMV can help with planning dives using tanks of various sizes.

Calculating RMV from SAC - Imperial units

In the imperial system, tank sizes are described using two values; capacity in Cuft at a rated pressure in psi.

For example, a common tank size is 80 Cuft at 3000 psi.

To convert SAC in [psi/minute] to RMV in [Cuft/minute], calculate how many Cuft are stored per psi, then multiply this by the SAC to get RMV.

For example, a SAC of 23 psi/min with an 80 Cuft 3000 psi tank would be an RMV of $(23 \times (80/3000)) = 0.61$ Cuft/min.

Calculating RMV from SAC - Metric units

In the metric system, tank sizes are described using a single number, the tank's physical size in liters [L]. This is how much gas could be stored at a pressure of 1 bar, so effectively the units of tank size are [L/bar].

This makes converting SAC to RMV easy. When using metric units, simply multiply the SAC by tank size.

For example, a SAC of 2.1 bar/min with a 10 L tank would be an RMV of $(2.1 \times 10) = 21$ L/min.



9.7. GTR calculations

Gas Time Remaining (GTR) is the time in minutes that can be spent at the current depth until a direct ascent to the surface at a rate of 10 m/min (33 feet/min) would result in surfacing with the reserve pressure. This is calculated using the current SAC value.

Safety stops and decompression stops are not considered by the GTR calculations.

To calculate GTR, start with the known tank pressure, P_{tank} . The remaining gas pressure, $P_{remaining}$, is determined by subtracting off the reserve pressure and the pressure used for the ascent.

$$P_{remaining} = P_{tank} - P_{reserve} - P_{ascent}, \text{ all tank pressures in [psi] or [bar]}$$

Knowing $P_{remaining}$, divide this by the SAC adjusted to the current ambient pressure to get GTR in minutes.

$$GTR = P_{remaining} / (SAC \times P_{amb,ATA})$$

Why aren't safety stops included?

Safety stops aren't included to simplify the meaning of GTR, and make it consistent across operating modes that do not include safety stops.

Managing enough gas for a safety stop is quite simple, especially since they require a relatively small amount of gas. For example, consider if your SAC was 1.4 bar/min (20 psi/min). At a depth of 4.5m/15ft, the pressure is 1.45 ATA. So a 3 minute safety stop would use $1.4 \times 1.45 \times 3 = 6.1$ bar (87 psi) of gas. This small amount of gas is easy to factor into the reserve pressure setting.

Why is GTR limited to no deco?

Currently, Shearwater does not believe that GTR is the proper tool for decompression dives, especially those involving multiple gases. This isn't to say AI in general

is not a good fit for all technical diving, but the GTR function becomes increasingly complex to manage and understand when multiple gases are used.

Overall, the required complexity of menus and setup burden on the user would result in a system prone to mistakes and accidental misuse, and not fitting with Shearwater's design philosophies.

Gas management is an incredibly important and also complex activity, especially for technical diving. Education, training, and planning are critical for proper gas management for technical dives. Shearwater feels that a convenience feature such as GTR is not a good application of technology in this case, as its complexity and potential for misuse would outweigh its utility.

No compensation for ideal gas law deviations

Note that all SAC and GTR calculations assume that the ideal gas law is valid. This is a good approximation up to about 207 bar (3000 psi). Above this pressure, the change in gas compressibility as pressure increases becomes a noticeable factor. This is mainly an issue for European divers using 300 bar cylinders. The end result is early in the dive, when pressures are above 207 bar/3000 psi, the SAC is over-estimated, resulting in under-estimation of GTR (although this is the good way to err, as it is more conservative). As the dive progresses and pressure drops, this problem rectifies itself and the numbers become more accurate.



9.8. Transmitter Connection Issues

If you are seeing “No Comms” errors, follow these steps:

If the “No Comms” is persistent:

- Check that the proper serial number is entered into the AI Setup Transmitter Setup menu.
- Ensure the Transmitter battery is not dead.
- Ensure the transmitter is turned on, by connecting it to a first stage and turning on the tank valve. Applying high pressure > 3.5 bar (50 psi) is the only way to turn on the transmitter.

The indicator light on a Swift transmitter will flash to indicate it is transmitting.

All compatible transmitters will power off after 2 minutes of no pressure.

- Bring the handset within range (1m / 3ft) of the transmitter. Having the transmitter too close (less than 5 cm / 2 inches) can also cause communication loss.

If the “No Comms” is intermittent:

- Search for sources of radio frequency (RF) interference, such as HID lights, scooters, suit heaters, or photo flashes. Try eliminating such sources to see if this solves the connection problem.
- Check the distance from transmitter to handset. If range related dropouts are occurring during diving, locating the transmitter on short length of high pressure hose is possible to decrease the transmitter to handset distance.
- If more than one legacy or compatible third party transmitter is in range of the computer, ensure that they have different transmit timings (grey vs. yellow coloured transmitters), to minimize interference. This is not usually a source of problems with Shearwater Swift transmitters.



10. Menus

Menus perform actions and allow settings to be changed.

If no buttons are pushed for 10 seconds, the menu system will time-out, returning to the main screen. Anything that had been previously saved will be retained. Anything that was in the middle of editing will be discarded.

The main Petrel 3 menu can be accessed using the left (MENU) button from the main screen.

Main menu items differ by mode, as well as at the surface versus on a dive. The most commonly used menu items are placed first in the main menu to reduce button presses.



In the following section each item will be covered in detail.

Adaptive Menus

Only menus necessary for the current mode are shown. This keeps operation simple, prevents mistakes, and reduces button presses.

10.1. Menu Structure

The following menu structure corresponds to the 3-Gas Nitrox mode. Air and Nitrox modes have less complex menus.

Some items are only available at the surface.

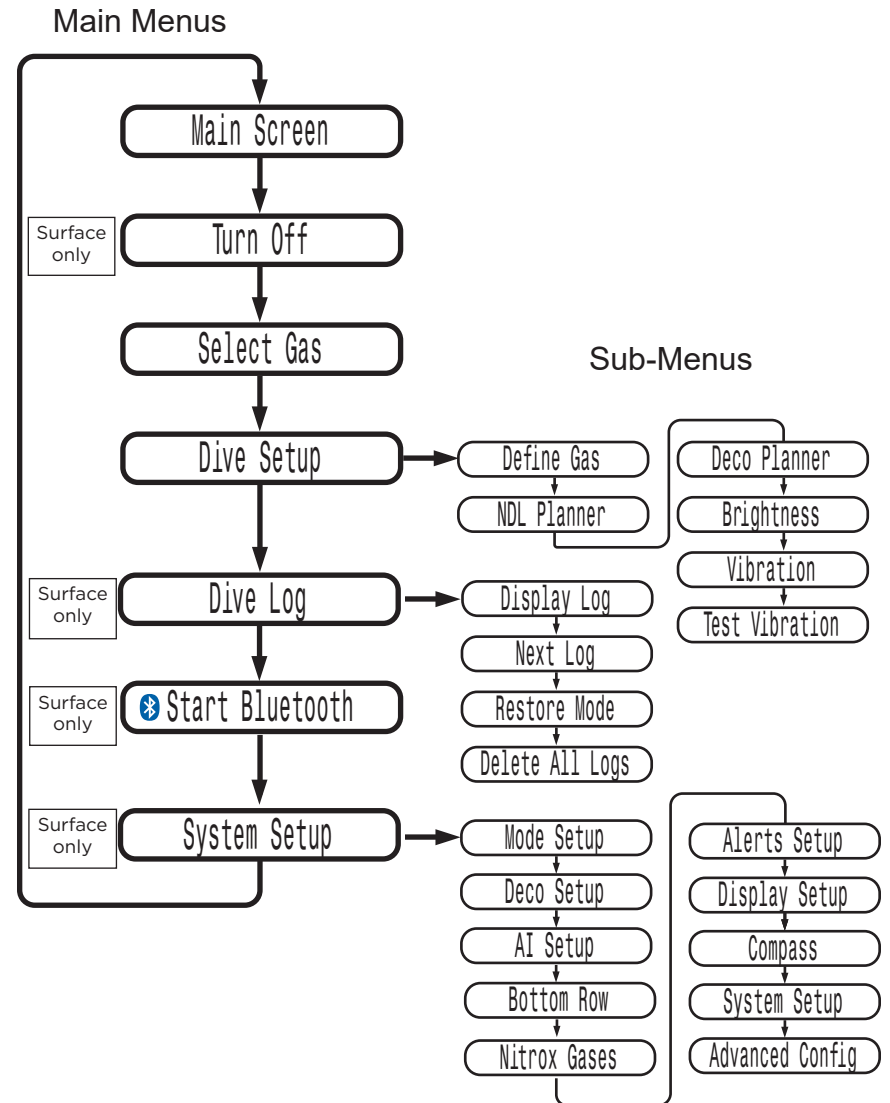



10.2. Turn off

The “Turn Off” item puts the computer to sleep. While sleeping, the screen is blank, but the tissue contents are maintained for repetitive diving. The “Turn Off” menu item will not appear during a dive. It will also not appear after a dive until the End Dive Delay Time has expired to allow for a continuation dive.

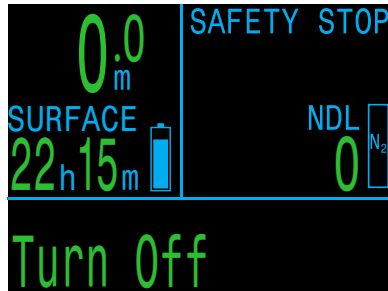

End Dive

This menu item will replace Turn Off when on the surface and still in dive mode.

The Petrel 3 will automatically exit dive mode once 1 minute (default End Dive Delay setting) has been spent at the surface. Use this menu command to exit dive mode sooner.

Adjust the End Dive Delay in System Setup>Adv. Config. More information can be found on [page 60](#).

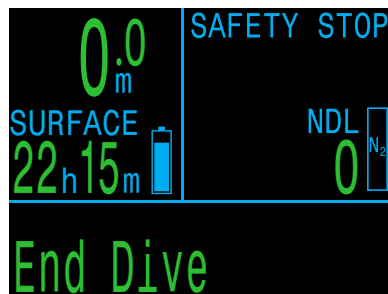

10.3. Select Gas (3 GasNx only)

This menu item allows you to pick a gas from the gases you have created.

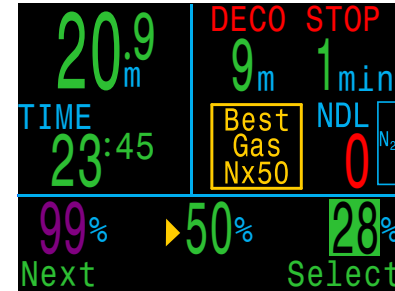

Select Gas example:
- 99% is turned off
- 28% is the active gas
- 50% is automatically queued for selection

Use the left (MENU) button to increment to the desired gas, then press the right (SELECT) button to select that gas.

The currently active gas is highlighted in white and an “Active” label will appear when you scroll over it.

A gas that is programmed, but off will be shown in **Magenta**. Currently off gases can still be selected. It will be turned on automatically if it is selected. Off gases are not used in decompression calculations.

When a gas change is suggested, the recommended best gas will be automatically queued up for selection when entering the Select Gas menu to minimize button presses.



Gases will not turn off automatically

Selecting a new gas will turn that gas on if it is off, but gases will never turn off automatically.

It is important to turn off all gases you do not plan to use on the dive in the Define Gas menu to ensure you receive accurate decompression information.



10.4.Dive Setup

The sub-menus in Dive Setup are available both on the surface and while diving (unlike System Setup which is not available while diving).

Define Gas

The Define Gas menu appears the same as the Select Gas menu, but allows turning gas on or off, and editing their oxygen percentage (the remaining percentage is assumed to be nitrogen).

In 3 GasNx mode gases may be edited and turned on or off during a dive.

In Nitrox mode Define Gas is found in the top level menu and the current gas can be edited on a dive.

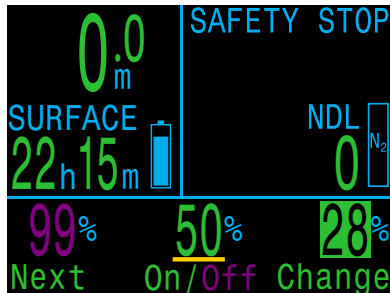

Note: The highlighted gas is the currently active gas. You can't turn off the active gas. You can edit it, but you will need to switch gases to turn it off.



Turn off gases you are not carrying

The decompression algorithm assumes that the diver is carrying and plans to use every gas that is currently turned on. Leaving gases that are not expected to be used turned on will result in inaccurate time to surface, decompression stop and decompression time information being displayed.

NDL Planner

The No-Decompression Limit (NDL) Planner is a quick way to determine how much bottom time is available until mandatory decompression stops would be required.

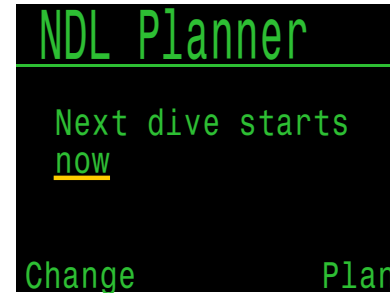

DEPTH	NDL	Gas
12m	85min	Air
15m	49min	Air
18m	30min	Air
18m	21min	Air

Next Exit

A surface interval duration from none up to 1 day can be applied to account for expected off-gassing.

The results are a list of depths, along with the NDL time at that depth and the best of the programmed gases to use at that depth. Only programmed gases are used.

The NDL Planner is only available in recreational dive modes.



Deco Planner (3 GasNx mode only)

Introduction

- Calculates decompression profiles for simple dives.
- Calculates gas consumption based on RMV

The Petrel 3's deco planner is best suited to decompression diving. For no-decompression diving, use the quick NDL Planner described on the previous page.

Setup

The planner uses the current gases programmed in the current dive mode, as well as the current conservatism (GF low/high) settings.

When used on the surface

Enter the expected surface interval, bottom depth, bottom time, and respiratory minute volume (RMV).

Note: Residual tissue loading (and CNS%) from recent dives will be used in calculating the profile

When the correct values are entered, select "Run Plan" and confirm decompression settings and starting CNS.

```

OC Depth Time RMV
   040 020 15
Enter Bottom Time
in minutes
Min: 5
Max: 180
Change Next
    
```

```

OC Depth Time RMV
   040 020 15
Ready to Plan Dive
GF: 30/70
Last Stop: 3m
Start CNS: 0%
Exit Plan
    
```

When used during a dive

Computes the decompression profile assuming the ascent will begin immediately. There are no settings to enter. (RMV is last used value)



Deco Planner Limitations

The Petrel 3's Deco Planner is intended for simple dives.

Multi-level dives are not supported.

The Deco Planner does not provide thorough validation of the profile. For example, it does not check for nitrogen narcosis limitations, gas usage limitations, or CNS percentage violations.

The user is responsible for ensuring a safe profile is followed.



Important!

The Petrel 3's Deco Planner makes the following assumptions:

- Descent rate is 18m/min (60ft/min) and the ascent rate is 10m/min (33ft/min).
- The gas in use at any time will be the gas with the highest PPO2 within the PPO2 limits.
- The planner will use the configured last stop depth.
- The RMV is the same during the bottom phase of the dive as it is while traveling and during deco

[Read more about PPO2 Limits on page 61.](#)



Results Screens

The results are given in tables showing:

Stp:	Stop Depth	In meters or feet
Tme	Stop Time	In minutes
Run	Run Time	In minutes
Gas	Gas Used	%O2
Qty	Quantity Used	In liters or Cuft

The first few rows will show the bottom time (bot) and the ascent time (asc) to ascend to the first stop. Multiple initial ascent legs may be shown if gas switches are needed

```

00 Depth Time RMV
   040 020 15
Stp Tme Run Gas Qty
40 bot 20 28% 1419
21 asc 22 28% 115
12 asc 23 50% 36
12 1 24 50% 33
9 1 25 50% 29
Quit Next
    
```

```

00 Depth Time RMV
   040 020 15
Stp Tme Run Gas Qty
6 3 28 50% 73
3 6 34 50% 118
Quit Next
    
```

If more than 2 stops are needed, the results will be split onto several screens. Scroll down to step through the screens.

A summary screen shows the total dive time, the time spent on deco and final CNS% after the last page of the decompression schedule.

```

00 Depth Time RMV
   040 020 15
Gas Usage, in Liters
50%: 287
28%: 1534
Quit Next
    
```

Brightness

Change the brightness of the computer's screen.

The display brightness has four fixed brightness settings plus an Auto mode.

The fixed options are:

- 🔦 **Cave:** Longest battery life.
- 🔦 **Low:** Second longest battery life.
- 🔦 **Med:** Best mix of battery life and readability.
- 🔦 **High:** Easiest readability in bright sunlight.



Auto will use the light sensor to determine the brightness of the display. The more ambient light there is, the brighter the display will get. At depth, or in dark water, very little brightness is needed to see the display.

The Auto setting works well in most situations.

The brightness of the display is the major determinant of battery life. Up to 80% of the power consumption is to power the display. When battery is low, the maximum display brightness is automatically reduced to extend remaining operating time.



Vibration

Quickly change the vibration function on or off.



Test Vibration

Quickly test the vibration function to ensure it's working correctly.



Regularly test vibration alerts with the Test Vibration tool to ensure they are working and you can hear/feel them through your exposure suit.

10.5. Dive Log

Use the Dive Log menu to review logs stored on the Petrel 3. Up to 1000 hours of detailed logs can be stored at the default sampling rate of 10 seconds.

The Dive Log menu is only available when on the surface.



Display Log

Use this menu to display a list of logged dives and view details.

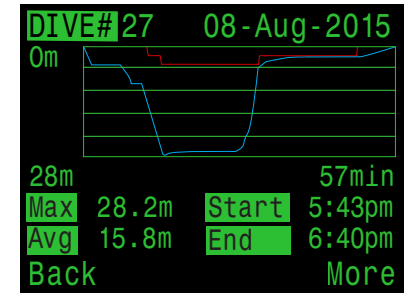
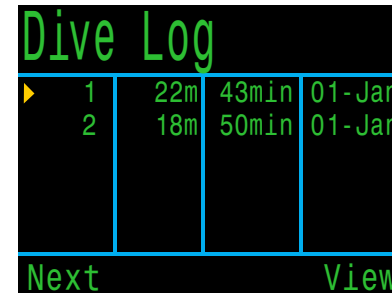

Select a dive to view from the Dive log list.

The profile of the dive is plotted in blue, with decompression stops plotted in red. The following information is displayed by scrolling through the dive log screens:

- Maximum and Average depth
- Dive number
- Date (dd-mon-yyyy)
- Start - Time of day dive started
- End - Time of day dive ended
- Length of dive in minutes
- Minimum, maximum, and average temperature
- Dive mode (Air, Nitrox, etc.)
- Surface interval preceding the dive
- Recorded Surface Pressure at the beginning of the dive
- Gradient factor settings used
- Start and end CNS
- Start and end pressure for up to 4 AI transmitters
- Average surface air consumption rate

Edit Log

Scrolling past all screens of an individual log brings up the Edit Log page where Dive number, Date, and Time can be changed, or the dive log can be deleted.

Next Log

The dive log number can be edited. This is useful if you want the dive computer log numbers to match your lifetime dive count.

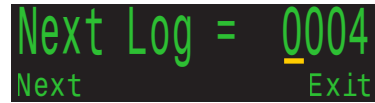

Next Log = 0004
Next Exit

This number will be applied to the next dive.

Restore Mode

Restore mode can be toggled on and off. When toggled on, it shows deleted logs, grayed out in the “Display Log” sub-menu. These dives can be restored to the Dive Log.



Restore Mode On
Next Edit

The Delete All Logs option is also changed to Restore All Logs when Restore mode is enabled.

Delete All Logs

Deletes All of the Logs.

Deleted Logs can be restored by toggling Restore Mode to on.



Delete All Logs
Next Delete

Start Bluetooth

Bluetooth is used for both firmware uploading and dive log downloading.



Start Bluetooth

Use this option to initialize Bluetooth on your dive computer.



11. System Setup Reference

System Setup contains configuration settings together in a convenient format for updating the configuration before a dive.

The sub-menus, pages, and configuration options differ considerably in each dive mode. This manual only covers recreational dive modes. See the Petrel 3 technical modes manual for a comprehensive description of the menus in technical modes.

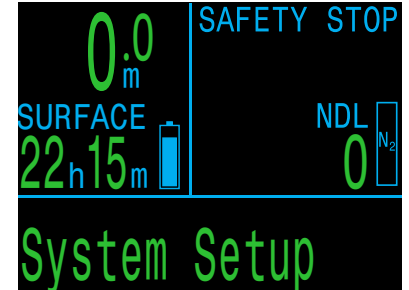

System setup cannot be accessed during a dive.



11.1. Mode Setup

The first sub-menu of System Setup is Mode Setup.

The appearance of this page changes slightly depending on the selected mode.

Dive Mode

There are 6 available dive modes:

- Air
- Nitrox
- 3 GasNx (default)
- OC Tec
- CC/BO
- SC/BO (Ext Models Only)
- PPO2 (Ext Models Only)
- Gauge
(E.g. bottom timer mode)

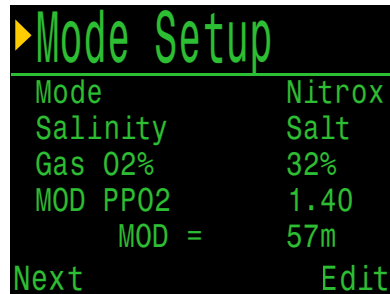

This manual only covers Air, Nitrox, 3 GasNx and Gauge mode. For the other modes, please see the Petrel 3 technical diving manual.

When changing to or from Gauge Mode, the decompression tissues are cleared. This is because the Petrel 3 does not know what gas you are breathing in this mode, and therefore cannot track inert gas loading. Plan repetitive dives accordingly.

For more information on which mode to choose, see [Dive Mode Differentiation on page 9](#).

Salinity

Water type (salinity) affects how the measured pressure is converted to depth.

Settings:

- Fresh
- EN13319 (default)
- Salt

Density of freshwater and saltwater differ by about 3%. Saltwater, being denser, will display a shallower depth for the same measured pressure versus the Fresh setting.

The EN13319 value is between Fresh and Salt. It is from the European CE standard for dive computers, and is the Petrel 3's default value.

Note that this setting only affects the depth displayed on the computer and has no impact on decompression calculations which rely on absolute pressure.

GAS O2%

In Nitrox mode, this is where the breathing Gas O2% is set.

In Air mode this setting is fixed at 21%.

In 3 GasNx mode, gases are setup. See [Nitrox Gases on page 57](#).

MOD PPO2

In air and Nitrox mode, this is where you set the Maximum Operating Depth PPO2 of your breathing gas.

The Default is 1.4. Do Not change this value unless you are sure you know what you are doing.



11.2. Deco Setup

Deco Model

By default this will show “Bühlmann ZHL16C GF” indicating that the Bühlmann ZHL-16C with gradient factors model is being used.



Optional VPM-B and DCIEM decompression algorithm unlocks are available at an additional cost. If applied, the deco model item allows the user to change between the available algorithms.

Conservatism

3 preset conservatism levels are available. In order of increasing conservatism:

- Low (45/95)
- Med (40/85)
- High (35/75)

Medium conservatism is the default setting.

A custom GF option is also available in every dive mode. If selected, GF Low and GF High fields will appear in the Deco Menu

For more information see [Decompression and Gradient Factors on page 28](#).



Do not Use a Custom GF if you don't understand the system.

Using a custom GF without fully understanding the implication of the changes you are making could cause unexpected and potentially hazardous increases or decreases to decompression obligation.

Last Stop

Only configurable in 3 GasNx mode.

Allows you to choose where to do your last mandatory decompression stop. This setting has no impact on safety stops.

The choices are 3m/10ft and 6m/20ft.

Safety Stops

The Safety Stop setting can be set to the following values:

- Off
- 3 minutes
- 4 minutes
- 5 minutes
- Adapt
- CntUp (Count Up)

When using the Adapt setting, a 3 minute safety stop will be used, unless the dive exceeds 30m (100ft) or the NDL falls below 5 minutes. In these cases a 5 minute safety stop is used.

The Count Up setting will count up from zero starting from when you enter the safety stop zone or when decompression obligations are cleared.

[Read more about Safety Stops on page 26.](#)



11.3. AI Setup

All AI settings must be configured on the surface before a dive, since the System Setup menu is not accessible during a dive.

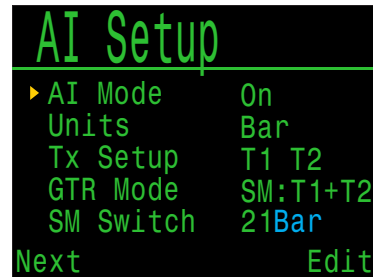

AI Mode

AI Mode is used to easily enable or disable AI.

AI Mode Setting	Description
Off	AI sub-system is completely powered down and consumes no power.
On	AI is enabled. When on, AI increases power consumption by about 10%.

Units

Choices are bar or psi.

TX Setup

The Transmitter setup (TX Setup) menu is used to set up transmitters. Currently active transmitters are shown next to TX Setup in the top level AI menu.

Up to 4 transmitters can be configured in this menu. Select a transmitter to modify its attributes.

Transmitter On/ Off

Turn off transmitters that are not currently in use to save battery power.

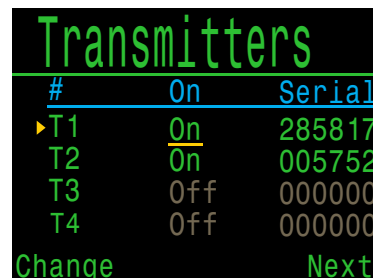
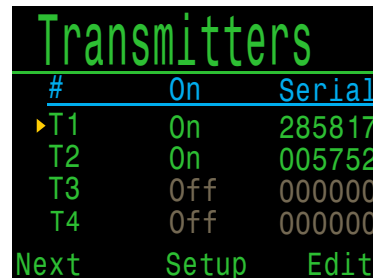

i Set AI Mode to OFF when AI not in use

Leaving AI enabled when not in use will negatively impact battery life when the computer is turned on. When a paired transmitter is not communicating, the Petrel 3 goes into a higher power scan state. This increases power consumption to about 25% higher than with AI off. Once communications are established, power drops to about 10% higher than with AI off.

Note, AI is never active when the computer is off. There is no need to turn AI off when the computer is turned off.

Tank Setup

Navigate over to and select a transmitter's serial number in the transmitter setup menu to enter the tank set up menu for that transmitter.

Serial Number Setup

Every transmitter has a unique 6-digit serial number. This number is etched onto the side of the transmitter.

Enter the serial number to pair the transmitter to T1. This number only needs to be entered once. Like all settings, it is stored in permanent memory. Transmitter settings are saved across all dive modes.

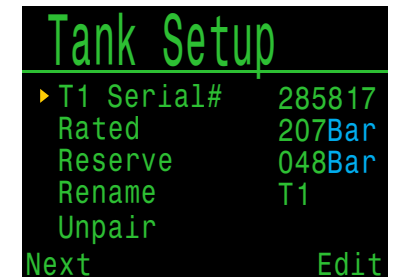



Rated Pressure

Enter the rated pressure of the tank on which the transmitter is installed.

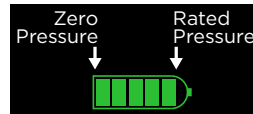

The valid range is 69 to 300 bar (1000 to 4350 psi).

The only use of this setting is to scale the full-scale range of the gas pressure bar graph that appears over the numerical tank pressure number.

Reserve Pressure

Enter the reserve pressure.

The valid range is 28 to 137 bar (400 to 2000 psi).

The reserve pressure setting is used for:

1. Low pressure warnings
2. Gas Time Remaining (GTR) calculations

A “**Reserve Pressure**” warning will be generated when the tank pressure falls below this setting.

A “**Critical Pressure**” warning will be generated when the tank pressure falls below the larger of 21 bar (300 psi) or half the reserve pressure.

For example, if reserve pressure is set to 48 bar, the critical warning will occur at 24 bar (48/2). If the reserve pressure is set to 27 bar, the critical warning will occur at 21 bar.

Rename

Allows the changing of the transmitters title as it appears on menus and screens throughout the dive computer. Two characters can be customized per tank. The options are:

First Character: T,S,B,O, or D.

Second Character: 1,2,3, or 4.

Unpair

The unpair option is simply a shortcut to reset the serial number to 000000.

When not using T1 or T2, for lowest power consumption, disable receiving completely by setting the AI Mode setting to Off.

GTR Mode

Gas Time Remaining (GTR) is the time in minutes that can be spent at the current depth and SAC rate until a direct ascent to the surface at a rate of 10 m/min (33 feet/min) would result in surfacing with the reserve pressure. The SAC rate is averaged over the last two minutes of diving for calculating GTR.



GTR and SAC are only based on one tank, or on two tanks in sidemount configuration. Note that for sidemount the tanks must be of identical volume for SAC to be accurate.

The GTR/SAC setting is also used for identifying sidemount mode. Selecting a SM option here will enable tank switch notifications.

GTR Mode Setting	Description
Off	GTR is disabled. SAC is also disabled.
T1, T2, T3, or T4	Selected Transmitter is used for GTR and SAC calculations.
SM:T1+T2 (Or similar)	Combined SAC for selected transmitters will be calculated and used for GTR. Sidemount switch notifications will be enabled.



11.4. Bottom Row

Configure and preview the bottom row in this menu.

The left position always displays the current gas.

The center and right positions are user configurable. For a complete list of configuration options, see [Configurable Info Row](#) on page 13.

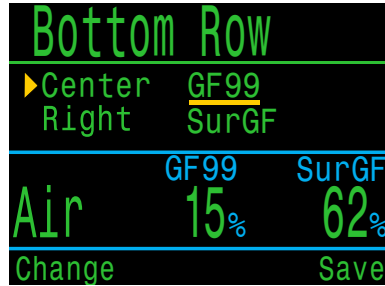

Mini Display Setup

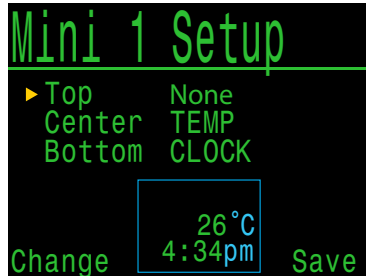
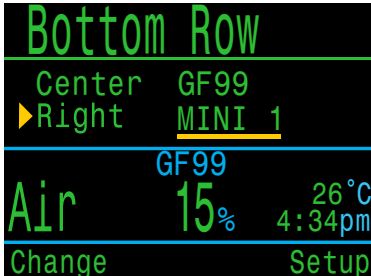

The Petrel 3 has a mini display function that allows it to show 3 pieces of information in each of the custom slots at the expense of font size.

Selecting one of the two mini display items in the Bottom Row setup menu will bring you to the Mini Display Setup Menu for that mini display.

Note that not all mini-displays will show units due to space constraints.

11.5. Nitrox Gases

This page is used to define up to 3 nitrox gases in the 3 GasNx dive mode.

Note that gases may also be edited (even during a dive) in the Dive Setup menu. However, the maximum operating depth PPO2 setting cannot be edited in Dive Setup.

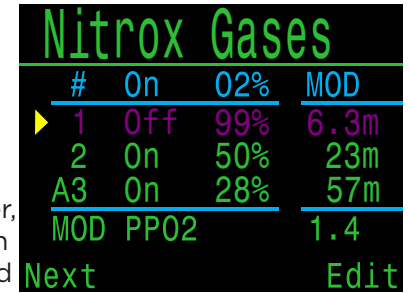

Each gas can be set from 21% O2 to 99% O2. The remaining percentage is assumed to be nitrogen.

The active gas is shown with a leading 'A'. A gas that is turned off is drawn in magenta (purple).

The maximum operating depth (MOD) values are not editable directly and are only controlled by the MOD PPO2 value.

MOD PPO2 can be set from 1.0 to 1.69 in steps of 0.01.

11.6. Alerts Setup

This page is used to set up custom dive alerts for Maximum Depth, Time, and Low NDL. Notifications will be triggered when these values are exceeded.

You can also toggle the vibration function from this page.

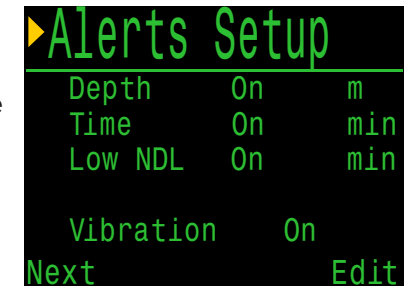

See [Customizable Alerts](#) on page 23 for more information on how these alerts are displayed.



11.7. Display Setup

Depth and Temperature

Depth: Feet or Meters

Temperature: °F or °C

Brightness

See brightness options on [page 50](#).

Altitude

The altitude setting on the Petrel 3 is fixed to Auto in recreational modes. This indicates that the computer will automatically compensate for pressure changes when diving at altitude.

Flip Screen

This function displays the contents of the screen upside down.

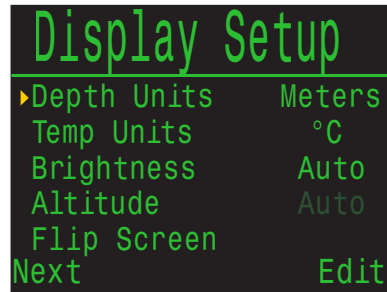

Determination of Surface Pressure

Accurate depth measurements and decompression calculations require knowing the ambient atmospheric pressure at the surface. Regardless of the turn on method, the surface pressure is determined the same way. While in the off state the surface pressure is measured and saved every 15 seconds. A 10 minute history of these pressure samples is kept. Immediately after turn on this history is examined and the minimum pressure is used as the surface pressure. The surface pressure is then remembered, and not updated again until the next turn on.

11.8. Compass

Compass View

The Compass View setting can be set to the following options:

Off: The compass is disabled.

60°, 90°, or 120°: Sets the range of the compass dial that is visible on the main screen. The actual amount of arc that there is room for on the screen is 60°, so this may feel the most natural. The 90° or 120° settings allow a wider range to be seen at once. The default is 90°.

True North (declination)

Enter the declination of current position to correct compass to true north.

This setting can be set from -99° to +99°.

If matching an uncompensated compass, or navigation is based on relative directions, then this setting can be left at 0°.

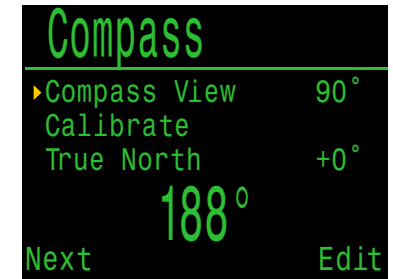



Calibrate

Calibration of the compass may be needed if the accuracy drifts over time or if a permanent magnet or ferromagnetic metal (e.g. iron or nickel) object is mounted very close to the Petrel 3. To be calibrated out, such an object must be mounted with the Petrel 3 such that it moves along with the Petrel 3.

Calibrate the Compass Each Battery Change

Each battery has its own magnetic signature, mostly due to its steel case. Therefore, recalibrating the compass when changing batteries is recommended.

Compare the Petrel 3 with a known good compass or fixed references to determine if calibration is needed. If comparing against fixed references, remember to consider the local deviation between Magnetic North and True North (declination). Calibration is typically not needed when traveling to different locations. The adjustment needed then is the True North (declination).

When calibrating, rotate the Petrel 3 smoothly through as many 3D twists and turns as possible in 15 seconds.

Compass Calibration Tips

The following tips will help ensure a good calibration:

- Stay away from metal (especially steel or iron) objects. For example, wrist watches, metal desks, boat decks, desktop computers, etc. These can all interfere with the Earth's magnetic field.
- Rotate to as many 3D positions as possible. Upside down, sideways, on edge, etc.
- Compare with an analog compass to check calibration.

11.9. System Setup

Date

Allows the user to set the current date.

Clock

Allows the user to set the current time. The format can be set to AM, PM or 24 hour time.

Unlock

Only to be used at the direction of Shearwater technical support.

Log Rate

Sets how often dive samples are added to the computer's log. More samples will give a higher resolution dive log at the expense of log memory. Default is 10 seconds. Maximum resolution is 2 seconds.

Reset to Defaults

The final 'System Setup' option is 'Reset to Defaults'. This will reset all user changed options to factory settings and/or clear the tissues on the dive computer. 'Reset to Defaults' cannot be reversed.

Note: This will not delete dive logs, or reset dive log numbers.

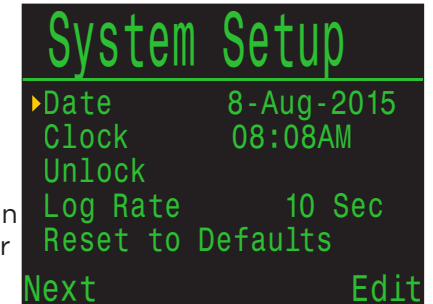



11.10. Advanced Config

Advanced configuration contains items that will be used infrequently and can be ignored by most users. They provide more detailed configurations.

The first screen allows you to enter the advanced configuration area, or to set the advanced configurations settings to their default.

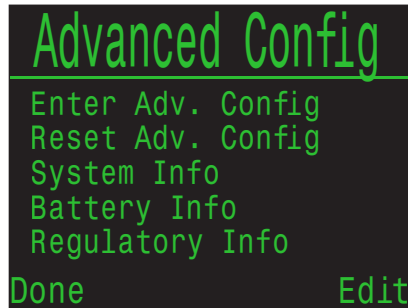

Reset Adv. Config

This will reset all advanced config values to their default settings.

Note: This will not affect other computer settings, delete dive logs, or reset dive log numbers.

System Info

The System Info section lists the computer's serial number as well as other technical information you may be asked to provide to tech support for troubleshooting purposes.

Battery Info

This section gives additional information on the type of battery being used and battery performance.

Regulatory Info

This section is where a user can find the specific model number of their computer as well as additional regulatory information.

Advanced Config 1

Main Colour

Main colours can also be changed for added contrast. Default is green but can be changed to red.

Title Colour

The title colors can be changed for added contrast or visual appeal. Default is Cyan, with gray, white, green, red, pink, and blue also available.

End Dive Delay

Sets the time in seconds to wait after surfacing before ending the current dive.

This value can be set from 20 seconds to 600 seconds (10 minutes). Default is 60s.

This value can be set to a longer time if you want brief surface intervals connected together into one dive. Some instructors use a longer end dive delay when teaching courses. Alternatively, a shorter time can be used to exit dive mode more quickly upon surfacing.

Battery Icon

The behavior of the battery icon can be changed here. Options are:

- **Surf+Warn:** The battery icon always displays when on the surface. During dive it displays only if there is a low battery warning.
- **Always:** The battery icon always displays.
- **Warn Only:** The battery icon only appears when there is a low battery warning.

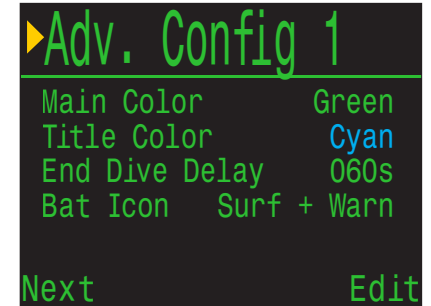



Advanced Config 2

PPO2 Limits

This section allows changing of PPO2 limits.



WARNING

Do not change these values unless you fully understand the effect.

All values are in absolute atmospheres [ATA] of pressure. (1 ATA = 1.013 bar)

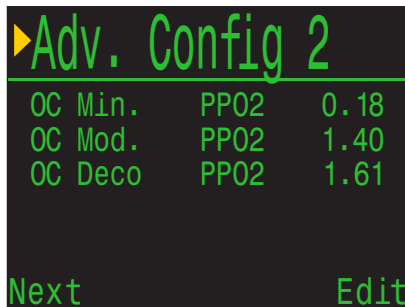

OC Low PPO2

PPO2 of all gases display in flashing red when less than this value. (Default 0.18)

OC MOD PPO2

This is the maximum allowable PPO2 during the bottom phase of the dive - **Maximum Operating Depth**. (Default 1.4)

This MOD setting is the same as can be edited in Mode Setup (for Air and Nitrox modes) and in the Nitrox Gases (for 3 GasNx mode).

OC Deco PPO2

All decompression predictions (Deco schedule and TTS) assume that the gas used for decompression at a given depth will be the gas with the highest PPO2 that is less than or equal to this value. (Default 1.61)

Suggested gas switches (when the current gas is displayed in yellow) are determined by this value. If you change this value, please be sure you understand its effect.

For example, if lowered to 1.50, then a switch to oxygen (99/00) will not be assumed at 6m/20ft.

Bottom Gases Vs. Deco Gases

In Air only and Nitrox modes, all gases are considered bottom gases and obey OC MOD PPO2 limit, even in decompression.

In 3 GasNx mode, the least oxygen rich mix is considered a bottom gas and obeys the OC MOD PPO2 limit. Other gases are considered deco gases and obey Deco PPO2 limit.

Advanced Config 3

Button Sensitivity

This menu allows some fine tuning of button sensitivity. This can be useful to adjust downward if you often experience accidental button presses.





12. Firmware Update and Log Download

It is important to keep the firmware on your dive computer up to date. In addition to new features and improvements, firmware updates may address important bug fixes.

There are two ways to update the firmware on your Petrel 3:

- 1) With Shearwater Cloud Desktop
- 2) With Shearwater Cloud Mobile



Upgrading the firmware resets decompression tissue loading. Plan repetitive dives accordingly.



During the update process, the screen may flicker or go blank for a few seconds

12.1. Shearwater Cloud Desktop

Ensure you have the most recent version of Shearwater Cloud Desktop. [You can get it here.](#)

Connect to Shearwater Cloud Desktop

On your Petrel 3, start Bluetooth by selecting the Bluetooth menu item from the main menu.

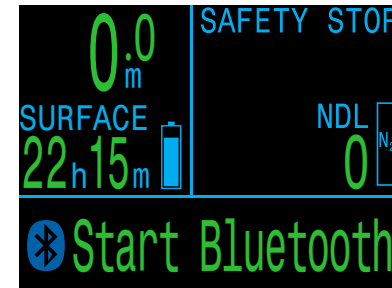

In Shearwater Cloud Desktop:

1. Click the connect icon to open the connect tab.
2. Scan for Dive Computer
3. Once you've connected the computer once, use the Petrel 3 tab to connect faster next time

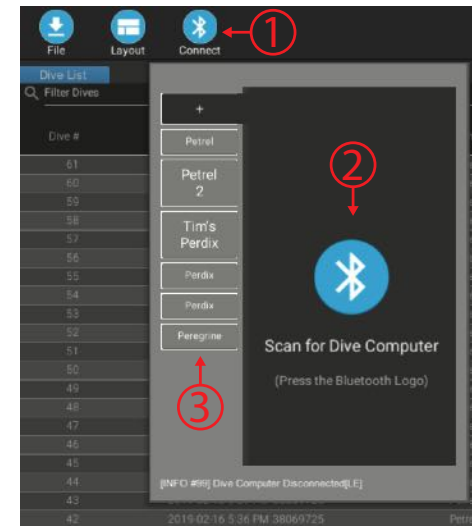

Shearwater Cloud Desktop Connect Tab



Once the Petrel 3 is connected, the connect tab will show a picture of the dive computer.

Download Dives

Select “Download Dives” from the connect tab.

A list of dives will be displayed and you can deselect any dive logs you don’t want to download, then press OK.

Shearwater Cloud Desktop will transfer the dives to your computer.

From the connect tab, you can give the Petrel 3 a name. If you have multiple Shearwater dive computers, you will be able to easily tell which dive was downloaded from which dive computer.



Shearwater Cloud Desktop Connect Tab



Select the dives you wish to download and press OK

Update Firmware

Select “Update Firmware” from the connect tab.

Shearwater Cloud Desktop will automatically select the latest available firmware.

When prompted, select your language and confirm the update.

The Petrel 3 screen will give percentile updates of receiving the firmware, and then Shearwater cloud will read “Firmware successfully sent to the computer” on completion.



Firmware updates can take up to 15 minutes.

Update Start-up Text

Start-Up text appears at the top of the start up splash screen when the Petrel 3 is turned on. It’s a great place to put your name and phone number so your computer can be more easily returned if misplaced.

Update Start-up Image

Here you can also change the startup image that appears when the Petrel 3 turns on to help better differentiate your dive computer.

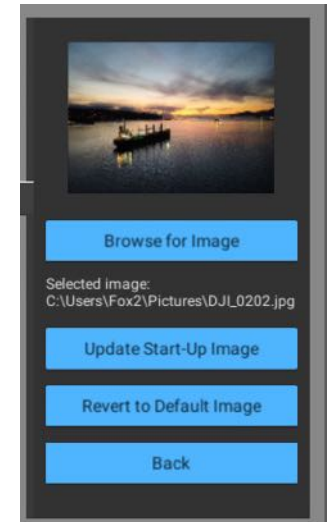

Update Start-up Image



12.2. Shearwater Cloud Mobile

Ensure you have the most recent version of Shearwater Cloud Mobile.

Download it from [Google Play](#) or the [Apple App Store](#).

Connect to Shearwater Cloud Mobile

On your Petrel 3, start Bluetooth by selecting the Bluetooth menu item from the main menu.



On Shearwater Cloud Mobile:

1. Press the connect icon at the bottom of the screen
2. Select your Petrel 3 from the list of Bluetooth devices

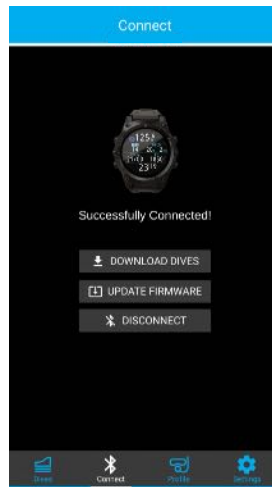

Download Dives

Select “Download Dives”

A list of dives will be displayed and you can deselect any dive logs you don’t want to download, then press OK.

Shearwater Cloud will transfer the dives to your smart phone.

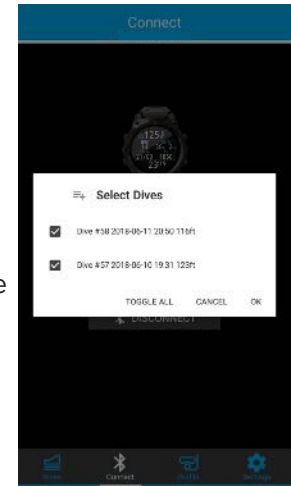

Update Firmware

Once the Petrel 3 is connected to Shearwater Cloud Mobile, select “Update Firmware” from the connect tab.

Shearwater Cloud mobile will automatically select the latest available firmware.

When prompted, select your language and confirm the update.

The Petrel 3 screen will give percentile updates of receiving the firmware, and then the mobile app will read “Firmware successfully sent to the computer” on completion.



Firmware updates can take up to 15 minutes.



13.Changing the Battery

A large coin or washer is required to change the battery

Remove the battery cap

Insert the coin or washer into the battery cap slot. Unscrew by turning counter clockwise until the battery cap is free. Be sure to store the battery cap in a clean dry space.

Exchange the battery

Remove the existing battery by tilting the Petrel 3 and letting the old battery slide out. Insert a new battery positive contact first. A small diagram on the bottom of the Petrel 3 shows the proper orientation.

Reinstalling the battery cap

It is **very important that the battery cap O-rings are clear of dust or debris**. Carefully inspect the O-rings for any debris or damage and gently clean. It is recommended that the battery cap's O-ring is lubricated on a regular basis with an O-ring lubricant compatible with Buna-N (Nitrile) O-rings. Lubricating helps ensure that the O-ring seats properly and does not twist or bunch.

Insert the battery cap into the Petrel 3 and compress the battery contact springs. While the springs are compressed rotate the battery cap clockwise to engage the threads. Be sure not to cross thread the battery cap's threads. Tighten the battery cap until snug and the Petrel 3 powers on. Do not over tighten the battery cap.

NOTE: Battery cap O-rings are Type 112 Buna-N 70 durometer.

Battery Type Selection

After changing the battery, select the battery type used.

The Petrel 3 attempts to guess what type of battery is being used. If the battery type is incorrect, it should be manually edited.

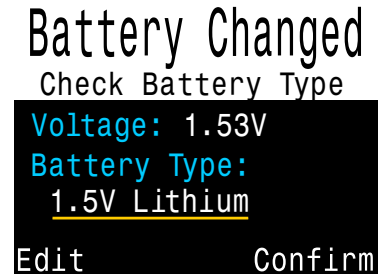

The Petrel 3 can accept most AA sized (14500 size) batteries that output a voltage between 0.9V and 4.3V. However, some batteries are better than others.

- Not all batteries support vibration.
- Battery types that support the fuel gauge feature will give more warning before the computer dies.
- Some battery types perform better in cold water.

Shearwater recommends using Energizer Ultimate Lithium batteries for best performance.

Supported battery types:

Battery Type	Approx. Battery Life	Vibration Support	Fuel Gauge	Cold water Performance
1.5V Lithium Recommended	60 hours	Yes	Yes	Very Good
1.5V Alkaline	45 hours	No	Yes	Ok
1.2V NiMh Rechargeable	30 hours	No	No	Poor
3.6V Saft LS14500	130 hours	No	No	Poor
3.7V Li-Ion Rechargeable	35 hours	Yes	Yes	Good

Battery life is based on medium brightness.



Alkaline batteries are especially prone to leaking. This is a leading cause of dive computer failure.
Alkaline batteries are not recommended.



13.1. Behavior on Battery Change

Settings

All settings are retained permanently. No loss of settings occurs when changing the battery.

Clock

The clock (time and date) is saved to permanent memory every 16 seconds when the dive computer is on, and every 5 minutes when off. When the battery is removed, the clock stops running. Once the battery is replaced, the clock is restored to the last saved value (so it is best to remove the battery while the dive computer is on for lowest error).

Quick battery changes will not require any adjustment, but the time should be corrected if the battery is removed for more than a few minutes.

Expected clock drift is about 4 minutes per month. If there is higher drift, it is likely due to clock stoppage during battery changes, and is easily corrected at the time of a battery change.

The clock is also updated every time the dive computer is connected to Shearwater Desktop or Shearwater Mobile.



After replacing the battery a screen appears for quick adjustments to the time

Decompression Tissue Loading

The battery may be safely changed between repetitive dives.

Like the clock, the decompression tissue loading is saved every 16 seconds to permanent memory when on, and every 5 minutes when off.

When the battery is removed the tissues remain stored in the permanent memory and are restored once the battery is replaced, allowing for battery changes between repetitive dives. However, the dive computer does not know for how long the battery was removed, so no surface interval adjustment is applied for the time that the battery is removed.

For quick battery changes, the un-powered time interval is not significant. However, if the battery is removed shortly after a dive and then remains out for a long period, residual tissue loading will remain when the battery is replaced.

If at the time of battery replacement any tissue is below saturated with air at the current pressure, then that tissue is brought up to being saturated with air. This might happen after a decompression dive that used 100% O₂, where the faster tissues are often completely depleted of inert gas loading. Bringing such tissues back up to saturated with air after a battery change is the most conservative approach.

When deco tissues are reset:

- Inert gas tissue loadings are set to saturated with air at current atmospheric pressure
- CNS Oxygen Toxicity set to 0%
- Surface Interval time set to 0
- All VPM-B values set to default levels



14. Storage and Maintenance

The Petrel 3 dive computer should be stored dry and clean.

Do not allow salt deposits to build up on the dive computer. Rinse the computer with fresh water to remove salt and other contaminants.

Do not wash under high pressure jets of water as it may cause damage to the depth sensor.

Do not use detergents or other cleaning chemicals as they may damage the dive computer. Allow to dry naturally before storing.

Store the dive computer **out of direct sunlight** in a cool, dry and dust free environment. Avoid exposure to direct ultra-violet radiation and radiant heat.

15. Servicing

There are no user serviceable parts inside the Petrel 3. Do not tighten or remove any faceplate screws.

Clean with water **ONLY**. Any solvents may damage the Petrel 3 dive computer.

Service of the Shearwater Petrel 3 may only be done at Shearwater Research, or by any of our authorized service centers.

Contact Info@shearwater.com for service requests.

Shearwater recommends service of all dive computers every 2 years by an authorized service center.

Evidence of tampering will void your warranty.

16. Glossary

CC - Closed circuit. Scuba diving using a rebreather where exhaled gas is recirculated with carbon dioxide removed.

GTR - Gas Time Remaining. The time, in minutes, that can be spent at the current depth and SAC rate until a direct ascent to the surface would result in surfacing with the reserve tank pressure.

NDL - No Decompression Limit. The time, in minutes, that can be spent at the current depth until mandatory decompression stops will be required.

O₂ - Oxygen gas.

OC - Open circuit. Scuba diving where gas is exhaled into the water (i.e. most diving).

PPO₂ - Partial Pressure of Oxygen, sometimes PPO2.

RMV - Respiratory Minute Volume. Gas usage rate measured as the volume of gas consumed, adjusted as if at a pressure of one atmosphere. Units of Cuft/minute or L/minute.

SAC - Surface Air Consumption. Gas usage rate measured as the rate of tank pressure change, adjusted as if at a pressure of one atmosphere (i.e. surface pressure). Units of psi/minute or bar/minute.



17. Petrel 3 Specifications

Specification	Petrel 3 Model
Operating Modes	Air Nitrox 3 GasNx (3 Gas Nitrox) OC Tec CC/BO SC/BO (FC & ACG Models only) PPO2 (FC & ACG Models only) Gauge
Display	Full color 2.6" AMOLED
Pressure (depth) sensor	Piezo-resistive
Accuracy	+/-20 mbar (at surface) +/-100 mbar (at 14bar)
Calibrated Depth Sensor Range (Maximum Rated Depth)	0 bar to 14 bar (130 msw, 426 fsw)
Crush Depth Limit	30 bar (-290msw) Note: this exceeds the calibrated depth sensor range.
Surface Pressure Range	500 mbar to 1040 mbar
Depth of dive start	1.6 m of sea water
Depth of dive end	0.9 m of sea water
Operating Temperature Range	+4°C to +32°C
Short-Term (hours) Temperature Range	-10°C to +50°C
Long-Term Storage Temperature Range	+5°C to +20°C
Battery	User Replaceable AA Size, 0.9V to 4.3V
Battery Operating Life (Display Medium Brightness)	45 Hours (AA 1.5V Alkaline) 60 Hours (1.5V Lithium) 130 Hours (SAFT LS14500)
Communications	Bluetooth Low Energy (4.0)
Compass Resolution	1°
Compass Accuracy	±5°
Compass Tilt Compensation	Yes, over ±45° pitch and roll
Dive Log Capacity	Approximately 1000 hours
Battery cap o-ring	Dual o-rings. Size: AS568-112 Material: Nitrile Durometer: 70A
Wrist Attachment	2 x 3/4" Elastic Straps with Buckles
Weight	Stand Alone (SA) Model - 266g Fischer Connector (FC) Model - 285g Analog Cable Gland (ACG) Model - 345g
Size (W X L X H)	83mm X 75.5mm X 39mm

18. Regulatory Information

A) USA-Federal Communications Commission (FCC)

THIS DEVICE COMPLIES WITH PART 15 OF THE FCC RULES. OPERATION IS SUBJECT TO THE FOLLOWING TWO CONDITIONS:

- (1) THIS DEVICE MAY NOT CAUSE HARMFUL INTERFERENCE, AND
- (2) THIS DEVICE MUST ACCEPT ANY INTERFERENCE RECEIVED, INCLUDING INTERFERENCE THAT MAY CAUSE UNDESIRE OPERATION.

Changes to or modification of this equipment are not authorized, doing so may void the user's authority to operate this equipment.

Note: This equipment has been tested and found to comply with the limits for a Class B digital device, pursuant to part 15 of the FCC Rules. These limits are designed to provide reasonable protection against harmful interference in a residential installation. This equipment generates, uses and can radiate radio frequency energy and, if not installed and used in accordance with the instructions, may cause harmful interference to radio communications. However, there is no guarantee that interference will not occur in a particular installation. If this equipment does cause harmful interference to radio or television reception, which can be determined by turning the equipment off and on, the user is encouraged to try to correct the interference by one or more of the following measures:

- Reorient or relocate the receiving antenna.
- Increase the separation between the equipment and receiver.
- Connect the equipment into an outlet on a circuit different from that to which the receiver is connected.
- Consult the dealer or an experienced radio/TV technician for help

Caution: Exposure to Radio Frequency Radiation.

This device must not be co-located or operating in conjunction with any other antenna or transmitter.

Petrel 3 Dive Computer Contains TX FCC ID: 2AA9B04



B) Canada - Industry Canada (IC)

This device complies with RSS 210 of Industry Canada.
Operation is subject to the following two conditions:

- (1) this device may not cause interference, and
- (2) this device must accept any interference, including interference that may cause undesired operation of this device.

L'utilisation de ce dispositif est autorisée seulement aux conditions suivantes :

- (1) il ne doit pas produire d'interférence, et
- (2) l'utilisateur du dispositif doit être prêt à accepter toute interférence radioélectrique reçue, même si celle-ci est susceptible de compromettre le fonctionnement du dispositif.

Caution: Exposure to Radio Frequency Radiation.

The installer of this radio equipment must ensure that the antenna is located or pointed such that it does not emit RF field in excess of Health Canada limits for the general population; consult Safety Code 6, obtainable from Health Canada's [website](#).

Petrel 3 Dive Computer Contains TX IC: I2208A-04

C) EU and UK Conformance Statements

- EC Type examination conducted by: SGS Fimko Oy Ltd, Takomotie 8, FI-00380 Helsinki, Finland. Notified Body No. 0598.
- UK EC Type examination conducted by: SGS United Kingdom Ltd, Rossmore Business Park, Ellesmere Port, South Wirral, Cheshire, CH65 3EN, United Kingdom. Approved Body No. 0120.
- High pressure gas sensing components are in conformity with EN250:2014 - respiratory equipment - open circuit self-contained compressed air diving apparatus - requirements, testing and marking - clause 6.11.1 Pressure Indicator.
- EN 250:2014 is the standard describing certain minimum performance requirements for SCUBA regulators to be used with air only sold in EU. EN 250:2014 testing is performed to a maximum depth of 50 M (165 FSW). A component of self-contained breathing apparatus as defined by EN250:2014 is: Pressure Indicator, for use with air only. Products marked EN250 are intended for air use only. Products marked EN 13949 are intended for use with gases containing more than 22% oxygen and must not be used for air
- Depth and time measurements conform with EN13359:2000 - Diving Accessories - depth gauges and combined depth and time monitoring devices
- Electronic instruments are in compliance with ETSI EN 301 489-1 Electromagnetic compatibility (EMC) standard for radio equipment and services; Part 1: Common technical requirements, EN 55035: 2017 Electromagnetic compatibility of multimedia equipment. Immunity requirements, CISRP32/EN 55032, 2015. A11:2020 Electromagnetic compatibility of multimedia equipment.
- Declarations of Conformity are available at: <https://www.shearwater.com/iso-9001-2015-certified/>

WARNING: Transmitters marked EN 250 are certified for use with air only. Transmitters marked EN 13949 are certified for use with Nitrox only.





19. Contact

www.shearwater.com/contact

Headquarters
100-10200 Shellbridge Way,
Richmond, BC
V6X 2W7
Tel: +1.604.669.9958
info@shearwater.com