



NERD·2

Operating Instructions

MANUAL

Revision B

CONTENTS

INTRODUCTION	5
MODELS COVERED BY THIS MANUAL	6
MODES COVERED BY THIS MANUAL	6
FEATURE LIST	7
BASIC OPERATION	8
TURNING ON	9
MOUNTING	11
THE MAIN SCREEN	16
COLOUR CODING	16
THE TOP ROW	17
THE CENTER ROW	21
CENTER ROW CONFIGURATION	22
THE BOTTOM ROW	24
INFO SCREENS	27
COMPASS	33
AIR INTEGRATION	37
OPERATING MODES	38
GAUGE MODE	41
STOPWATCH	41
RESETTABLE AVERAGE DEPTH	41
SIMPLE OC EXAMPLE DIVE	42
SIMPLE CC EXAMPLE DIVE	43
COMPLEX CC DIVE EXAMPLE	45
DECOMPRESSION AND GRADIENT FACTORS	49
MENUS	51
TURN OFF	56
CALIBRATION	57
SINGLE SENSOR MODE	58
DUAL SENSOR MODE	58
CALIBRATION PROBLEMS	59
SWITCH SETPOINT	60
SELECT GAS	61
RADIO STATION GASES	62
SELECT GAS MENU STYLES	63
CLASSIC STYLE SELECT GAS	63
NEW STYLE SELECT GAS	64
SWITCH TO CC/BO	65

CONTENTS

DIVE SETUP	65
LOW SETPOINT	65
HIGH SETPOINT	66
DEFINE GAS	67
DIVE PLANNER	70
CONSERVATISM	72
NDL DISPLAY.....	73
EXTERNAL PPO2 MONITORING	76
BRIGHTNESS	78
DIVE LOG MENU	79
DISPLAY LOG.....	79
NEXT LOG NUMBER	79
RESTORE MODE	80
DELETE ALL LOGS	80
SYSTEM SETUP	81
MODE SETUP.....	82
DECO SETUP	84
COMPASS SETUP	90
SYSTEM SETUP	92
ADVANCED CONFIGURATION 1.....	93
ADVANCED CONFIGURATION 2.....	94
STARTING BLUETOOTH	95
FIRMWARE UPDATE	95
FIRWARE UPLOAD USING SHEARWATER DESKTOP	96
FIRWARE UPLOAD USING SHEARWATER	97
CLOUD MOBILE	97
DIVE LOG DOWNLOAD	98
DIVE LOG DOWNLOADING	98
WITH SHEARWATER DESKTOP	98
DIVE LOG DOWNLOADING	100
WITH SHEARWATER CLOUD MOBILE	100
CHARGING	101
BEHAVIOR ON DEAD BATTERY	102
ALERT DISPLAYS	105
STORAGE AND MAINTENANCE	109
FCC WARNING	111
INDUSTRY CANADA WARNING	111
CONTACT	112



DANGER

This computer is capable of calculating deco stop requirements. These calculations are at best a guess of the real physiological decompression requirements. Dives requiring staged decompression are substantially more risky than dives that stay well within no-stop limits.

Diving with rebreathers and/or diving mixed gases and/or performing staged decompression dives and/or diving in overhead environments greatly increases the risk associated with of scuba diving.

YOU REALLY ARE RISKING YOUR LIFE WITH THIS ACTIVITY.



WARNING

This computer has bugs. Although we haven't found them all yet, they are there. It is certain that there are things that this computer does that either we didn't think about, or planned for it to do something different. Never risk your life on only one source of information. Use a second computer or tables. If you choose to make riskier dives, obtain the proper training and work up to them slowly to gain experience.

This computer will fail. It is not whether it will fail but when it will fail. Do not depend on it. Always have a plan on how to handle failures. Automatic systems are no substitute for knowledge and training.

No technology will keep you alive. Knowledge, skill, and practiced procedures are your best defense (except for not doing the dive, of course).







INTRODUCTION

The Shearwater NERD 2 is an advanced hands-free technical diving computer for open and closed circuit divers.

Although we strive to make the NERD 2 easy enough to use without reading the manual, please take some time to read this manual to get the best performance from your new computer. Diving involves risk and education is your best tool for managing this risk.

MODELS COVERED BY THIS MANUAL

This manual provides operating instructions for the following NERD 2 Models:

- Stand Alone Model (SA) 
- Fischer Connector Model 
- DiveCAN Rebreather Controller 
- DiveCAN Rebreather Monitor 

Some sections of this manual only apply to specific models of NERD 2. To help identify which sections are applicable to your unit, look for the corresponding model icon throughout this manual. Sections with no mode icons are applicable to all NERD 2 models.

MODES COVERED BY THIS MANUAL

This manual provides operating instructions for the NERD 2 in the following operating modes:

- Open Circuit Technical (OC Tec)
- Closed Circuit / Bail Out (CC/BO)
- Semi-Closed Circuit with Open Circuit bailout (SC/BO)
- Gauge
- Gauge with PPO2 (PPO2)

The Shearwater NERD 2 also has an Open Circuit Recreational mode (OC Rec). Operation for the NERD 2 in OC Rec mode is identical to that of the Shearwater Perdix. For detailed instructions on OC Rec mode, please see the Shearwater Perdix [Recreational Nitrox Mode Manual](#).

FEATURE LIST



- Depth, time and oxygen sensor display
- **Bühlmann decompression model with gradient factors conservatism**
- Optional VPM-B decompression model
- **Imperial and metric displays**
- Available in Standalone, Fischer and DiveCAN models
- **Any combination of oxygen, nitrogen, and helium (Air, Nitrox, Trimix)**
- Open and closed circuit, switchable during a dive
- **External (EXT) PPO2 monitoring from 1, 2 or 3 cells**
- Internal PPO2 mode with 2 set-points, each of which can be set between .4 and 1.5
- **Two PPO2 set-points, each of which can be set between .4 and 1.5**
- Automatic PPO2 set-point switching (configurable)
- **5 CC and 5 OC gases**
- Gases can be changed and added during a dive
- **CNS tracking**
- No lockout from violating deco stops
- **Rechargeable lithium-ion battery providing up to 18 hours of dive time**
- Tilt compensated digital compass
- **1000 hour dive log memory**
- Log downloads and firmware upgrades using Bluetooth
- **A menu system that adapts to diving status**
- Dual-transmitter Air integration
- Auto turn-off after 15 minutes on the surface
- **Depth sensor rated to 140msw (450 fsw)**

BASIC OPERATION

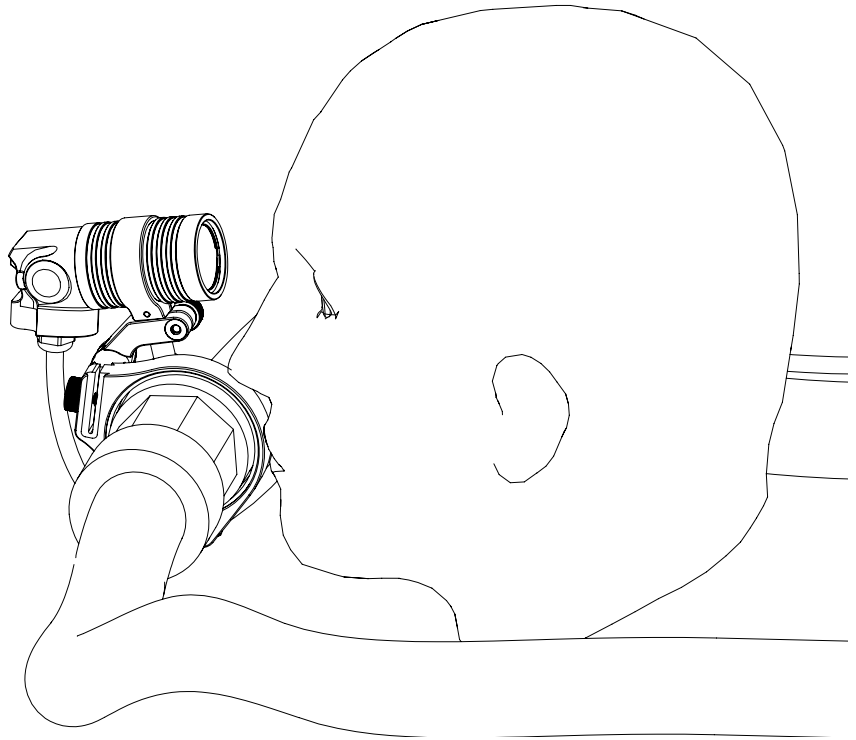

*(simulated representation of the display)

The NERD 2 is mounted in front of the face. The screen image floats in view for the entire dive, showing all information needed for technical, recreational or rebreather diving.

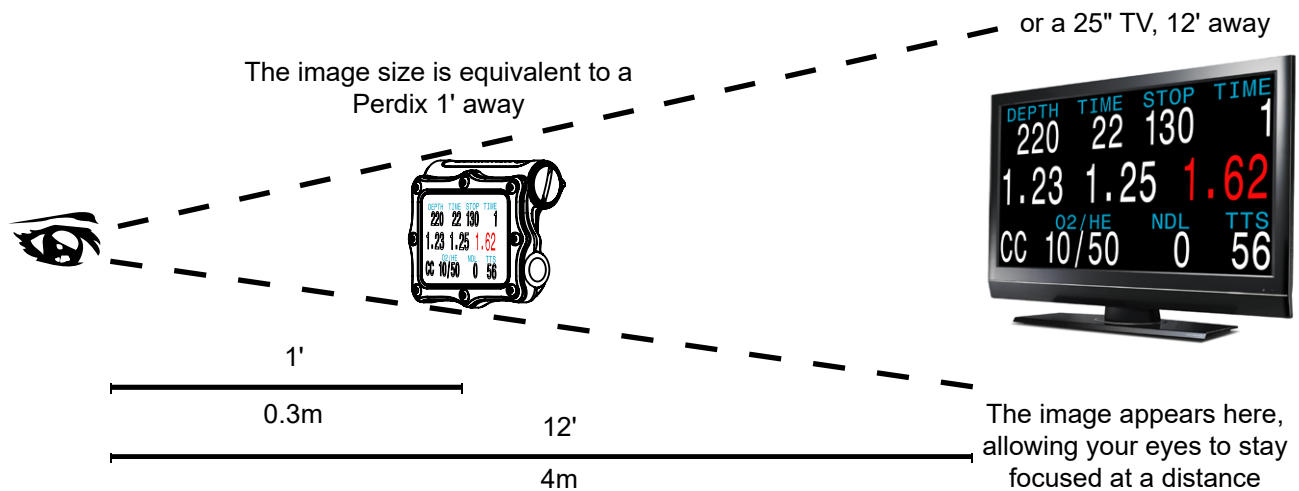

The image appears about 12' (4m) away, keeping your vision focused on the dive. You do not need to refocus closer to read the display. This means near vision correction is not needed nor wanted (a plus for those with aging eyes or who wear reading glasses).

TURNING ON

To turn the NERD 2 on, press both the MENU (left) and the SELECT (right) buttons at the same time.

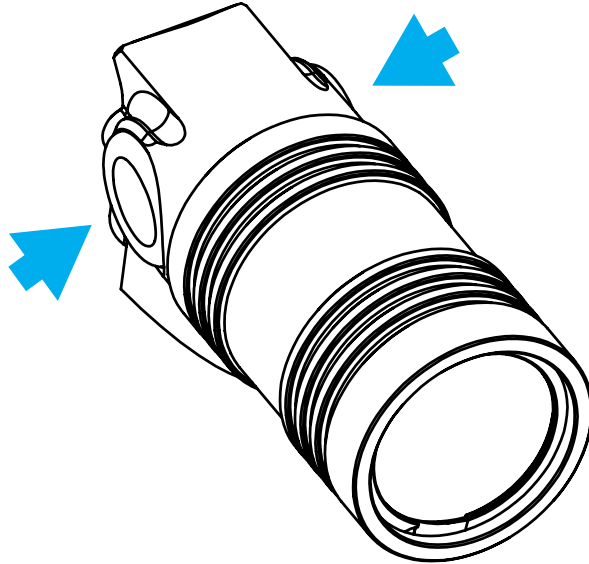

AUTO-ON

The NERD 2 will automatically turn-on when submerged underwater. This is based on pressure increase and not on the presence of water.



DO NOT RELY ON THE AUTO-ON FEATURE

This feature is supplied as a backup for when you forget to turn on your NERD 2. Shearwater recommends turning on manually before each dive to confirm proper operation and to double check battery status and setup.

AUTO-ON DETAILS

The NERD 2 turns on automatically when the absolute pressure is greater than 1100 millibar (mbar). For reference, normal sea level pressure is 1013 mbar and 1 mbar of pressure corresponds to approximately 1 cm (0.4") of water.

So the NERD 2 will automatically turn-on when about 0.9 m (3 ft) underwater when at sea level. If at higher altitude, then the NERD 2 auto-on will occur at a deeper depth. For example, when at 2000 m (6500 ft) altitude the atmospheric pressure is only about 800 mbar. Therefore, at this altitude the NERD 2 must be submerged underwater by 300 mbar to reach an absolute pressure of 1100 mbar. This means the auto-on occurs at about 3 m (10 ft) underwater when at an altitude of 2000 m.

BUTTONS

Two piezo-electric buttons are used to change settings and view menus.

i Except for turning the NERD 2 on, all operations are simple single button presses.

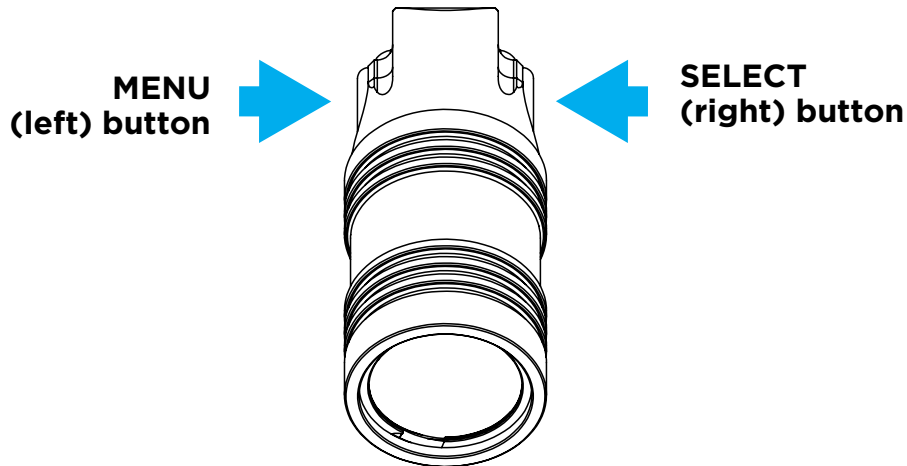

Don't worry about remembering all the button rules below. Button hints make using the NERD 2 easy.

MENU button (Left)

- From main screen > Brings up the menu
- In a menu > Moves to the next menu item
- Editing a setting > Changes the setting's value

SELECT button (Right)

- From main screen > Steps through information screens
- In a menu > Performs command or starts editing
- Editing a setting > Saves the setting's value

BOTH BUTTONS

When NERD 2 is off pressing MENU and SELECT at the same time will turn the NERD 2 on. No other operation requires pressing both buttons at the same time.

i BUTTON HINTS

When in a menu, button hints label each button.

For example, the hints to the right tell us:

- Use MENU to **change** the brightness value.
- Use SELECT to **save** the current value.

A screenshot of the NERD 2 menu interface. The screen is black with white text. At the top, there are three columns: 'DEPTH', 'TIME', and 'SURFACE'. Below these are values: '0', '2hr15mn', and '.70'. The word 'Brightness' is displayed in large white letters. Below it, the word 'Med' is displayed in yellow. At the bottom, there are two buttons: 'Change' and 'Save'. Below 'Change' is a blue box with the text 'MENU hint'. Below 'Save' is a blue box with the text 'SELECT hint'.

MOUNTING

MOUNTING THE NERD 2 ON AN OPEN CIRCUIT REGULATOR

The NERD 2 is designed to mount on your second stage regulator hose with the open circuit mount to ensure the eyepiece is easily viewable while diving. It does this with a removable mount that provides a solid platform and quick adjustment of the NERD 2.



CONSIDERATIONS WHEN USING THE NERD 2 FOR OPEN CIRCUIT DIVING

When using a regulator mounted computer, it is important to familiarize yourself with the impact it may have on emergency procedures. Note that a regulator mounted computer on your primary donating regulator may impede your ability to donate the regulator. In this scenario, you would also be donating your computer and would need a contingency strategy.

Regularly practicing emergency procedures with the gear you dive is the best way to prepare yourself to deal with an emergency.

STEPS FOR INSTALLING THE NERD 2 WITH THE OC MOUNT

- 1) Remove the collar screw from the NERD 2 mount with the hex key provided
- 2) Insert the NERD 2 into the retaining collar
- 3) Reinstall the collar screw
- 4) Open hose mount thumb screw
- 5) Secure NERD 2 on metal regulator hose end
- 6) Ensure the NERD 2 is not obstructing your regulator adjustment controls or purge button
- 7) Close hose mount thumb screw
- 8) For the SA model, Shearwater recommends using the included tether to act as extra insurance against losing your computer to a broken mount or lost thumbscrew. SA

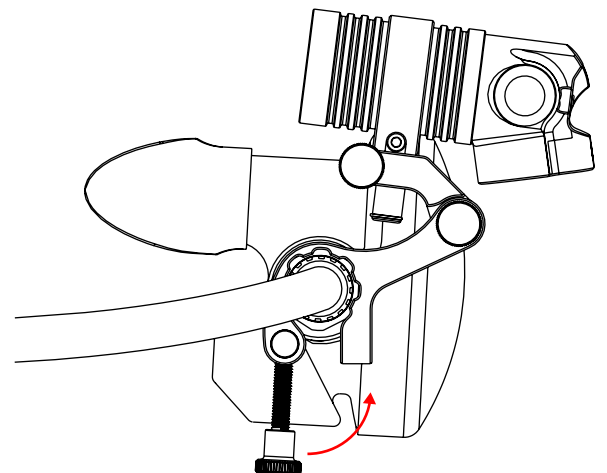
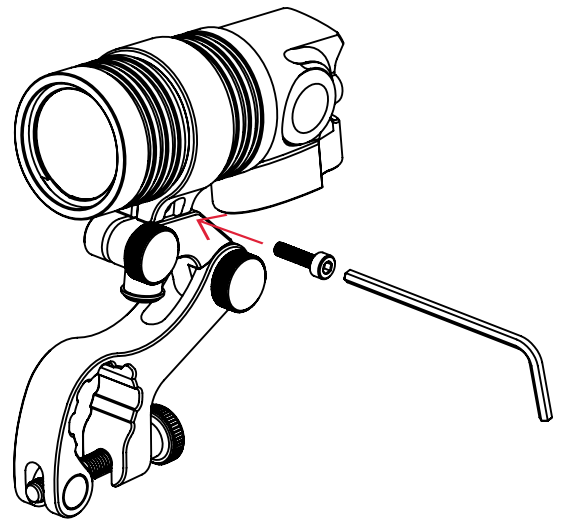
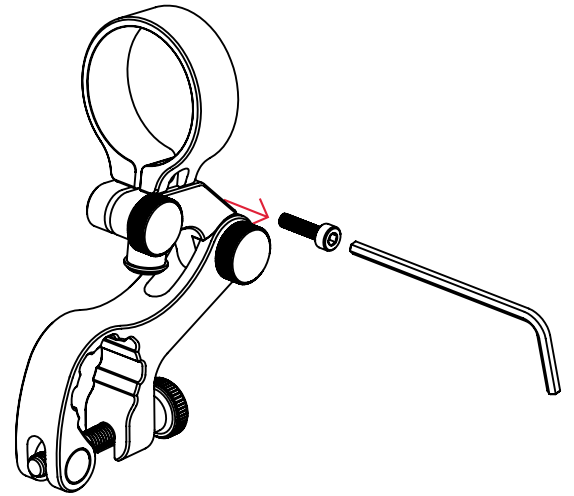

MOUNTING THE NERD 2 ON A CLOSED CIRCUIT LOOP

The NERD 2 is designed to mount on your rebreather loop with the closed circuit mount to ensure the eyepiece is easily viewable when diving. It does this with a removable mount that provides a solid platform and quick adjustment of the NERD 2.

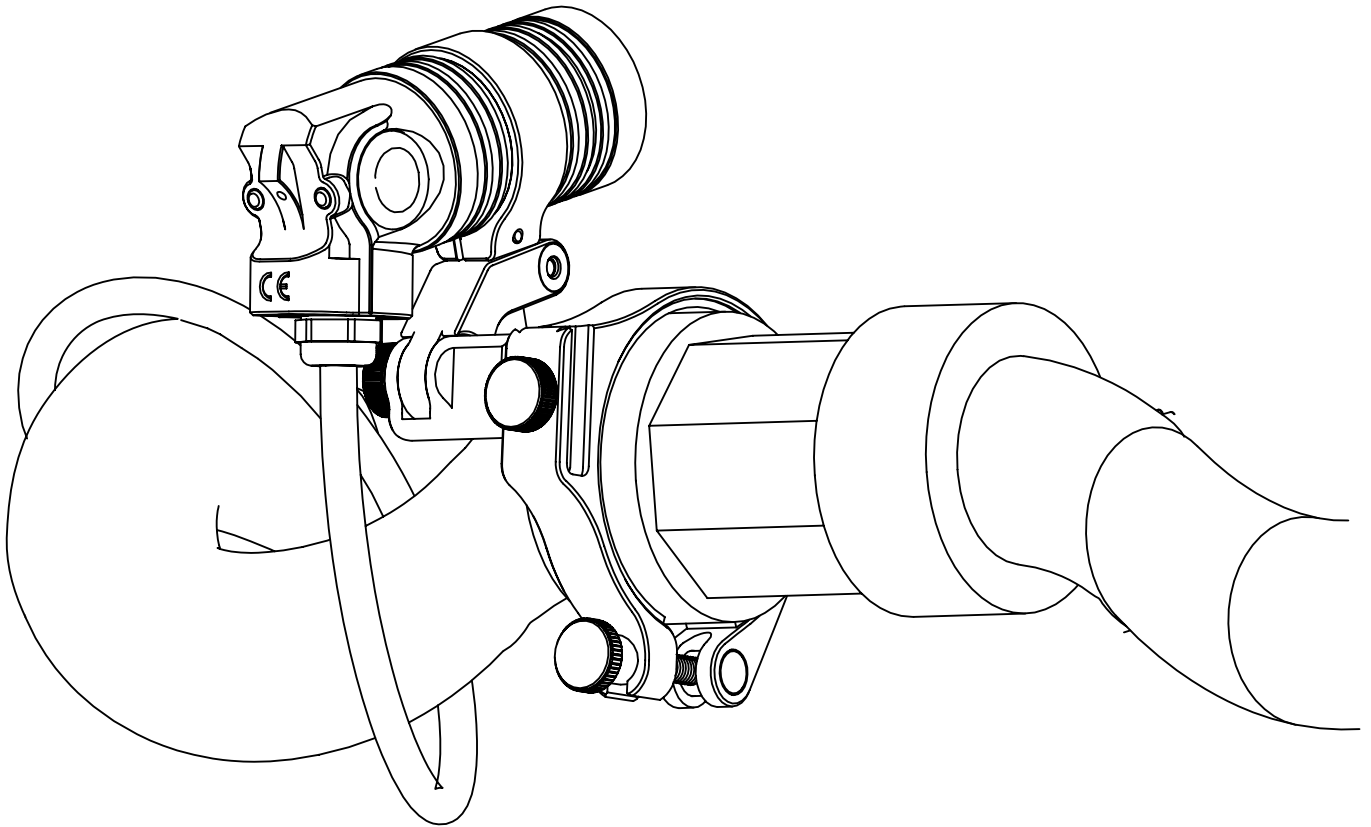

CONSIDERATIONS WHEN USING THE NERD 2 CLOSED CIRCUIT DIVING

When using a loop mounted computer, it is important to familiarize yourself with the impact it may have on emergency procedures. Note that in the event of a bailout, it may be difficult to continue using the NERD 2 as your primary computer without removing it from the loop.

Regularly practicing emergency procedures with the gear you dive is the best way to prepare yourself to deal with an emergency.

STEPS FOR INSTALLING THE NERD 2 WITH THE CC MOUNT

- 1) Insert and secure mounting slide
- 2) Insert NERD 2 into collar and secure with screw.
- 3) Mate loop mount and NERD 2 assembly
- 4) Select a location on your rebreather mouthpiece to mount the NERD 2. Location should be:
 - Free of obstructions
 - Roughly within your natural field of view
 - Sufficiently stiff to support the NERD 2
 - Sufficiently far away from your DSV/BOV to ensure that your DSV/BOV is not obstructed
- 5) Mount assembly to loop by closing the loop clamp thumbscrew

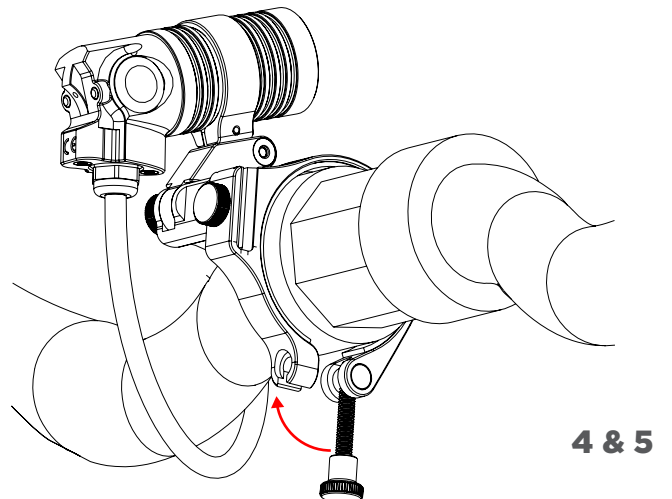
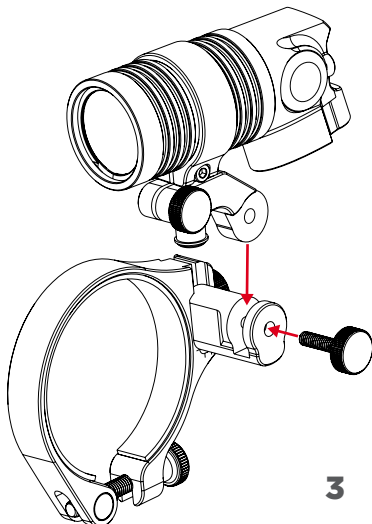
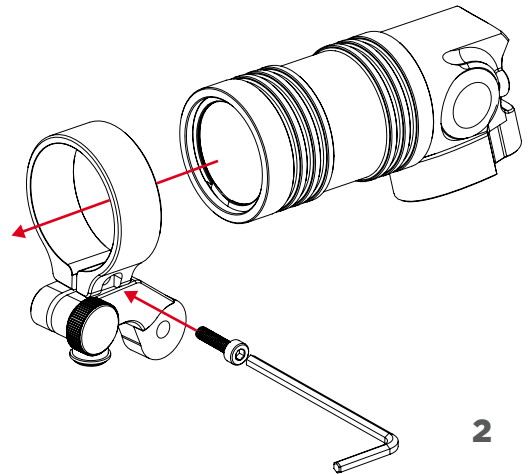
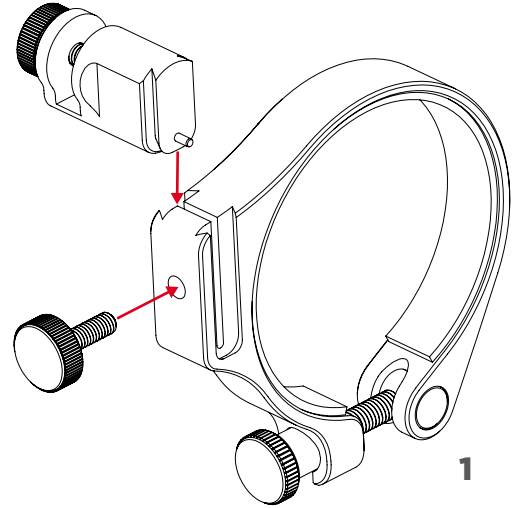

ALTERNATE MOUNTING FOR THE NERD 2

The NERD 2 incorporates mounting points that allow it to be backward compatible with some mounts designed for the original Shearwater NERD. In addition, these mounting points allow for a wide range of other mounting possibilities.

The following diagrams are provided to aid users in the development of custom mounting solutions.

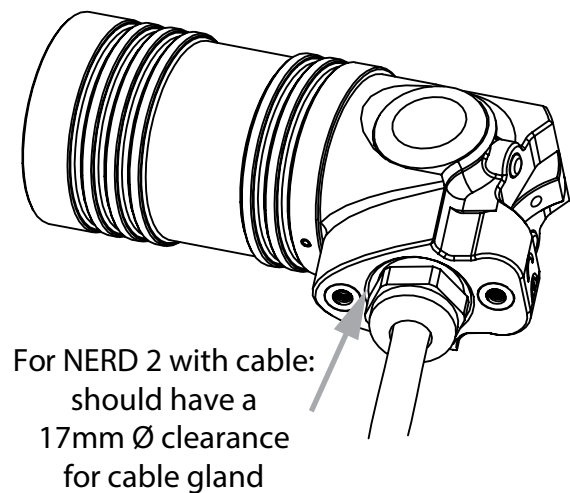
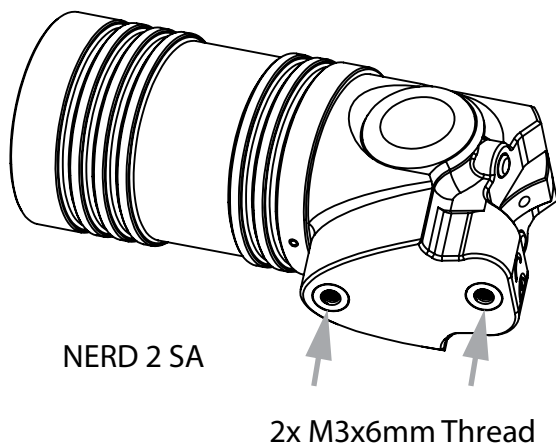
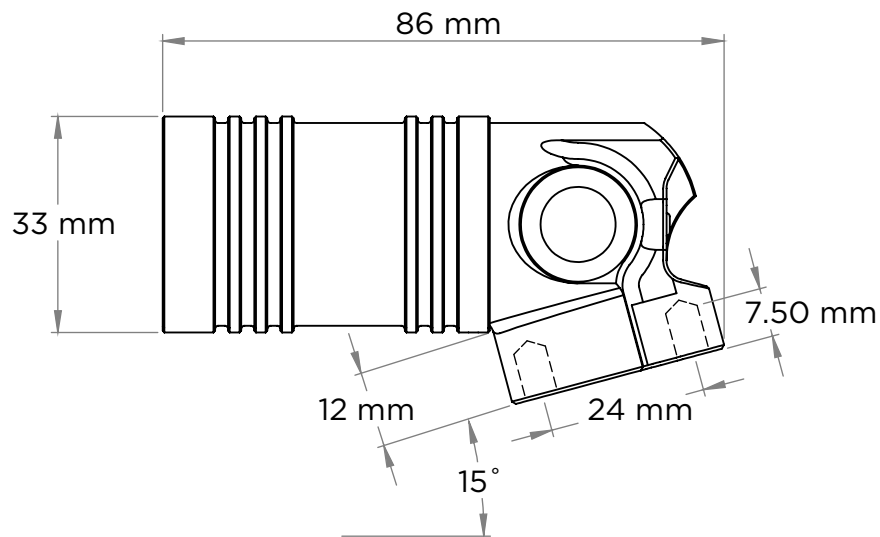

THE MAIN SCREEN

The main screen shows the most important information needed for technical diving.

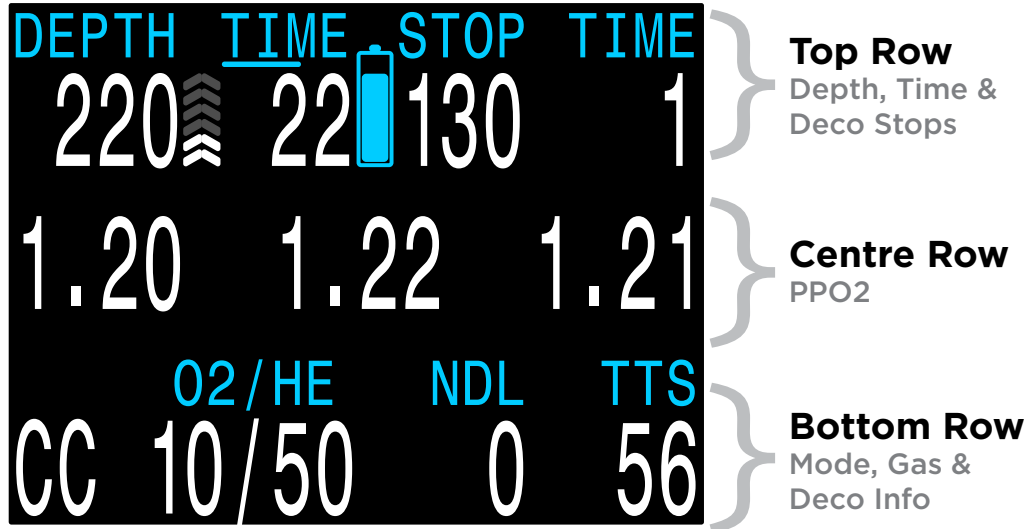

COLOUR CODING

Colour coding of text draws attention to problems or unsafe situations.

WHITE text indicates normal conditions.

YELLOW is used for warnings that are not immediately dangerous but should be addressed.

FLASHING RED is used for critical alerts that could be life threatening if not immediately addressed.



Sample warning - a better gas is available

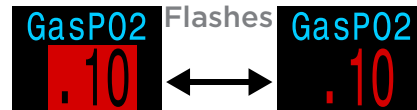

Sample critical alert - continuing to breathe this gas could be fatal

i COLOR BLIND USERS

The warning or critical alert states can be determined without the use of color.

Warnings display on a solid inverted background. Warning - doesn't flash.



Critical alerts flash between inverted and normal text. Critical alert - flashes.



THE TOP ROW

The top row shows depth and time information



Depth

Imperial: In feet
(no decimal places).

Metric: In meters (displays with
1 decimal place up to 99.9m)



Note: If the depth shows a Flashing Red zero or shows at depth at the surface, then the depth sensor needs service.

Ascent Bar Graph

Shows how fast you are currently ascending.

Imperial: 1 arrow per 10 feet per minute (fpm) of ascent rate.

Metric: 1 arrow per 3 meters per minute (mpm) of ascent rate.



White when 1 to 3 arrows
30 fpm / 9 mpm



Yellow when 4 to 5 arrows
50 fpm / 15 mpm



Flashes Red when 6 arrows plus
60+ fpm / 15+ mpm

Note: Deco calculations assume 33fpm (10mpm) ascent rate.

Dive Time

The length of the current dive in minutes.

The seconds display as a bar drawn below the word “Time.” It takes 15 seconds to underline each character in the word. Does not display the seconds bar when not diving.



Battery Icon

The default behavior is that the battery icon is shown on the surface but disappears when diving. If low or critical then the battery icon will appear while diving.

Yellow when the battery needs to be charged.

Red when the battery must be charged immediately.

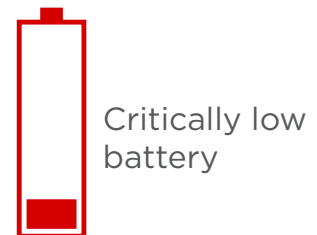
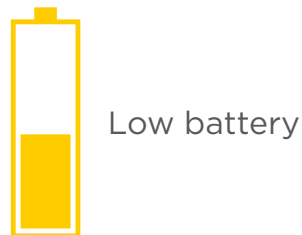

Stop Depth and Time

Stop - The next decompression stop depth in the current units (feet or meters).

This is the shallowest depth to which you can ascend.

Time - The time in minutes to hold the stop.



Will **Flash Red** if you ascend shallower than the current stop.



By default the NERD 2 uses a 10ft (3m) last stop depth. At this setting, you may perform the last stop at 20ft (6m) with no penalty. The only difference is that the predicted time-to-surface will be shorter than the actual TTS since off-gassing is occurring slower than expected.

There is also an option to set the last stop to 20ft (6m) if you wish.

Surface Interval

When on the surface, the STOP DEPTH and TIME are replaced by a surface interval display.

Shows the hours and minutes since the end of your last dive. Above 4 days, the surface interval is displayed in days.

The surface interval is reset when the decompression tissues are cleared. See the section on [Tissues Cleared](#).

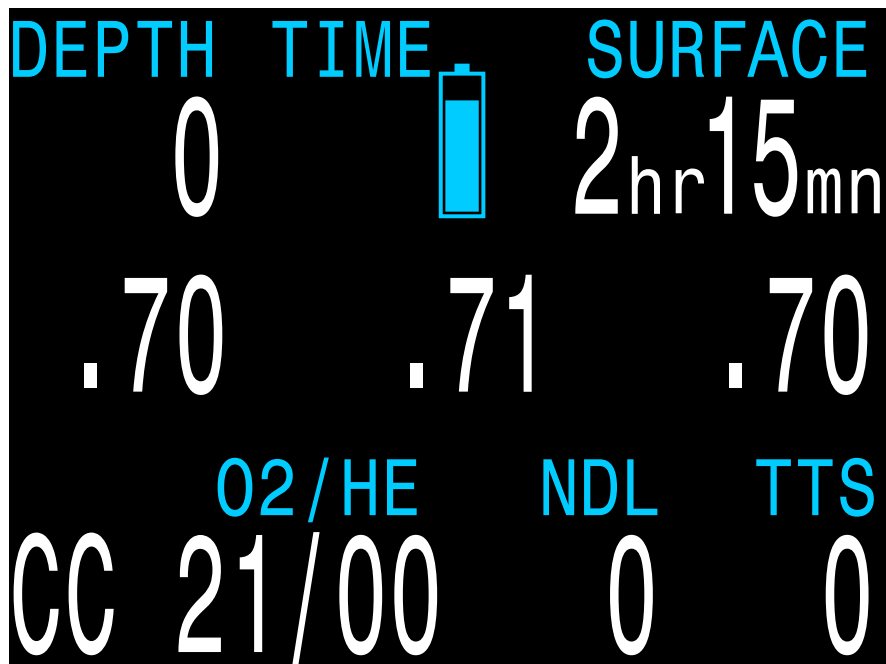

Sample surface main screen showing the surface interval

THE CENTER ROW

The center row displays PPO2. PPO2 units are absolute atmospheres (1ata = 1013mbar).

The layout varies depending on the current mode

Mode	Menu Setup	Center Row Display										
Open Circuit	<div style="border: 1px solid black; padding: 5px;"> <p>▶ Mode Setup</p> <table style="width: 100%; border-collapse: collapse;"> <tr> <td style="width: 50%;">Mode</td> <td>OC Tec</td> </tr> <tr> <td>Salinity</td> <td>Fresh</td> </tr> </table> <p>Next Edit</p> </div>	Mode	OC Tec	Salinity	Fresh	<div style="background-color: black; color: white; padding: 10px; text-align: center;"> <p style="color: cyan;">GasP02</p> <p style="font-size: 24pt;">1.15</p> <p>OC Gas PPO2</p> </div>						
Mode	OC Tec											
Salinity	Fresh											
Closed Circuit with Internal PPO2 Setpoints	<div style="border: 1px solid black; padding: 5px;"> <p>▶ Mode Setup</p> <table style="width: 100%; border-collapse: collapse;"> <tr> <td style="width: 50%;">Mode</td> <td>CC/B0</td> </tr> <tr> <td>Salinity</td> <td>Fresh</td> </tr> <tr> <td>PPO2 Mode</td> <td>Int.</td> </tr> <tr> <td>Low SP</td> <td>0.7</td> </tr> <tr> <td>High SP</td> <td>1.3</td> </tr> </table> <p>Next Edit</p> </div>	Mode	CC/B0	Salinity	Fresh	PPO2 Mode	Int.	Low SP	0.7	High SP	1.3	<div style="background-color: black; color: white; padding: 10px; text-align: center;"> <p style="font-size: 24pt;">1.3</p> <p>CC Internal Setpoint</p> </div>
Mode	CC/B0											
Salinity	Fresh											
PPO2 Mode	Int.											
Low SP	0.7											
High SP	1.3											
Closed Circuit with External PPO2 Monitoring	<div style="border: 1px solid black; padding: 5px;"> <p>▶ Mode Setup</p> <table style="width: 100%; border-collapse: collapse;"> <tr> <td style="width: 50%;">Mode</td> <td>CC/B0</td> </tr> <tr> <td>Salinity</td> <td>Fresh</td> </tr> <tr> <td>PPO2 Mode</td> <td>Ext.</td> </tr> </table> <p>Next Edit</p> </div>	Mode	CC/B0	Salinity	Fresh	PPO2 Mode	Ext.	<div style="background-color: black; color: white; padding: 10px; text-align: center;"> <p style="font-size: 24pt;">1.29 1.31 1.28</p> <p>CC External Measured PPO2</p> </div>				
Mode	CC/B0											
Salinity	Fresh											
PPO2 Mode	Ext.											

In CC mode, PPO2 displays in **Flashing Red** when less than 0.40 or greater than 1.6.

In OC mode, PPO2 displays in **Flashing Red** when less than 0.19 or greater than 1.65.

The above limits can be adjusted in the [Adv. Config 2](#) menu.

CENTER ROW CONFIGURATION

Unless 3 external PPO2 values are displayed, the center row displays can be customized.

In this case, the center position can only display PPO2. In OC only mode, the PPO2 display can optionally be turned off.

Configure the center row in the System Setup → Center Row Menu.

The left and right positions can be set to display the following:

The image shows a configuration menu on the left and a sample display on the right. The menu is titled "Center Row" and has the following options:

Left	Max Depth
Center	Gas PPO2
Right	None
Next	Edit

An arrow points from the "Center" option to a "Custom Display" box. The sample display shows the following data:

DEPTH	TIME	STOP	TIME
220	22	130	1
MAX	GasP02		
225 ft	1.15		
OC	O2/HE	NDL	TTS
15/40	0	56	

The centre row on the NERD 2 is configured the same way as on a Shearwater Petrel. See below for a video walkthrough of how to configure the center row.

 **Watch the video:**
[Configurable Center Row](#)

Center Row Options

Option	Description
None	Blank (default value).
Max Depth	The maximum depth of the current or previous dive.
Avg Depth	The average depth of the current or previous dive.
@+5	The TTS if remaining at current depth for 5 more minutes.
Δ+5	The difference between current TTS and @+5.
Ceil	The current decompression ceiling (not rounded to the stop interval).
GF99	The Bühlmann ZHL-16C super-saturation percent gradient.
CNS	Central Nervous System (CNS) toxicity clock as a percentage.
Clock	The time-of-day in 24hr or am/pm format (same as system setting). Does not show "am" or "pm".
DET	Dive End Time. The time-of-day when the dive will end (i.e. Clock plus TTS). In 24hr or am/pm format (same as system setting). Does not show "am" or "pm".
Compass	A mini compass as an optional display. Works like a regular compass with the red end of the needle always points to North.
Timer	Timer (stopwatch) display.
Compass	A miniature compass. Works like a regular compass with the red end of the needle always points to North.
TEMP	The current temperature in Celsius or Fahrenheit.
AI T1	The pressure transmitted by transmitter T1.
AI T2	The pressure transmitted by transmitter T2.
AI Mini	The pressure transmitted by transmitters T1 and T2 in a compact format.

THE BOTTOM ROW

The bottom row displays the current mode, gas and decompression information.

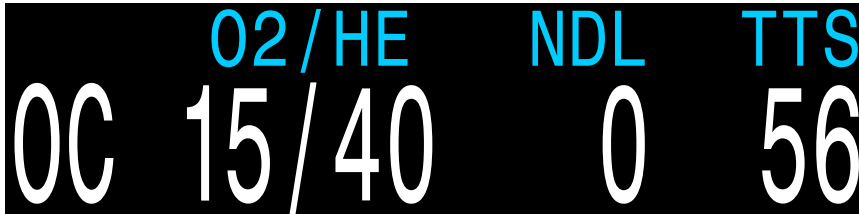

Circuit Mode

The current breathing configuration. One of:

OC OC = Open circuit

SC SC = Semi-closed circuit

CC CC = Closed circuit

BO BO = Bailout
(when CC available,
displays in **Yellow** to
indicate bailout condition)

Current Gas (O2/He)

02/HE
21/00

Air
⌒
21% O2
79% N2

The current gas shown as a percentage of Oxygen and Helium. The remainder of the gas is assumed to be Nitrogen.

02/HE
10/50

Tx
⌒
10% O2
50% He
40% N2

In closed circuit mode, this gas is the diluent. In open circuit mode this is the breathing gas.

02/HE
21/00

A better deco gas is available

Displays in **Yellow** when there is better deco gas available than the current gas.

No Decompression Limit (NDL)

A black rectangular display with the text "NDL" in cyan at the top and the number "20" in white below it.

The time remaining, in minutes, at the current depth until decompression stops will be necessary. Displays in **Yellow** when the NDL is less than 5 minutes.

A black rectangular display with the text "NDL" in cyan at the top and the number "5" in yellow below it.

Once NDL reaches 0 (i.e. deco stops needed), the NDL display is just wasting space. To address this, a few different values can be set to replace the NDL (see [Dive Setup](#) → [NDL Display](#)). The options are listed below.

NDL Replacement Options

A black rectangular display with the text "GF99" in cyan at the top and "80%" in white below it.

GF99: The raw percentage of the Bühlmann allowable supersaturation at the current depth.

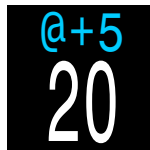
A black rectangular display with the text "@+5" in cyan at the top and the number "20" in white below it.

@+5: The predicted time-to-surface (TTS) if you were to stay at the current depth for 5 more minutes.

A black rectangular display with the text "CEIL" in cyan at the top and the number "74" in white below it.

CEIL: The current ceiling in the current units (feet or meters). **Flashes Red** if you ascend shallower than the current ceiling.

A black rectangular display with the text "TTS" in cyan at the top and the number "35" in white below it.

Time-to-Surface (TTS)

The time-to-surface in minutes. This is the current time to ascend to the surface including the ascent plus all required deco stops.

Assumes:

- Ascent rate of 33 feet per minute (10 meters per minute).
- Decompression stops will be followed.
- Programmed gases will be used as appropriate.

The bottom row is also used to show additional information.

By using only the bottom row for this additional information, the critical information contained on the Top and Center Rows is always available during a dive.

The additional information that can be displayed on the bottom row includes:

Info:

Shows additional dive information.

Info Screens:

Press SELECT (right button) to step through info screens.

Menus:



Allows changing settings.

Press MENU (left button) to enter menus.

Warnings:

Provide important alerts.

Press SELECT (right button) to clear a warning.

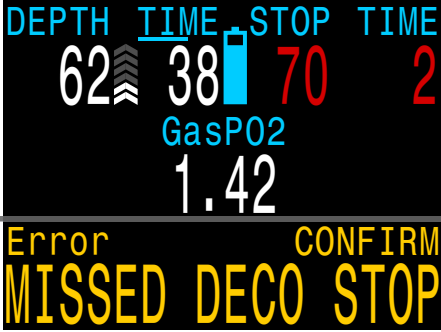
 <p>DEPTH TIME STOP TIME 220 22 130 1 GasP02 1.15 MAX AVG AvgATM 234ft 190ft 6.76</p>	 <p>DEPTH TIME STOP TIME 220 22 130 1 GasP02 1.15 Brightness Med Change Save</p>	 <p>DEPTH TIME STOP TIME 62 38 70 2 GasP02 1.42 Error CONFIRM MISSED DECO STOP</p>
Sample Info Screen	Sample Menu	Sample Warning

The bottom row is used to display additional information

INFO SCREENS



Info screens display on the bottom row.

Press SELECT (right) button to step through the info screens.

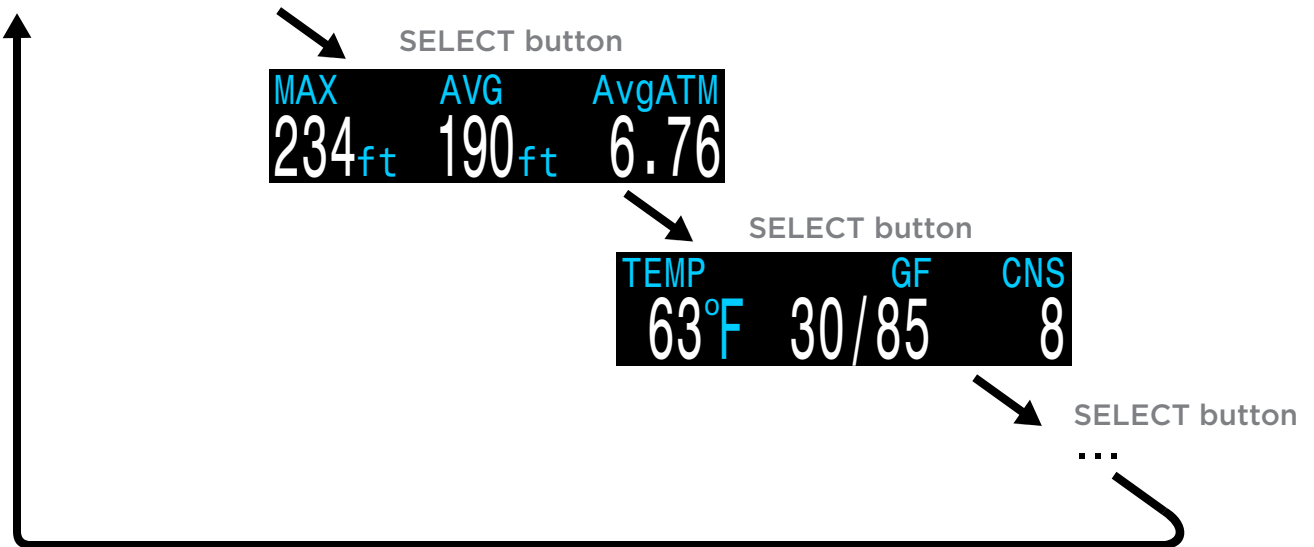

Info screens provide additional information that does not fit on the main screen.

Starting from the main screen, the SELECT (right) button steps through the info screens.

When all info screens have been viewed, pressing SELECT again will return to the main screen.

Except the compass and AI screens, info screens time-out after 10 seconds, returning to the main screen.

Pressing the MENU (left) button will also return to the main screen.

The info screen content is optimized for each mode. Set the NERD 2 to the mode you will be using (e.g. OC Tec) and step through the info screens to get familiar with the content.

The next section describes the individual values shown on the info screens.

AVG
50ft

Average Depth

Displays the average depth of the current dive, updated once per second. When not diving, shows the average depth of the last dive.

AvgATM
2.52

Average Depth in Atmospheres (AvgATM)

The average depth of the current dive, measured in absolute atmospheres (i.e. a value of 1.0 at sea level). When not diving, shows the average depth of the last dive.

MAX
260ft

Maximum Depth

The maximum depth of the current dive. When not diving, displays the maximum depth of the last dive.

CNS
11

CNS Toxicity Percentage

Central Nervous System oxygen toxicity loading percentage. Flashes Red when 100 or greater.

CNS
100

The CNS percentage is calculated continuously, even when on the surface and turned off. When deco tissues are reset, the CNS will also be reset.

The CNS value (short for Central Nervous System Oxygen Toxicity) is a measure of your exposure to elevated partial pressures of oxygen (PPO2) as a percentage of a maximum allowable exposure. As PPO2 goes up, the maximum allowable exposure time goes down. The table we use is from the NOAA Diving Manual (Fourth Edition).

During a dive the CNS never decreases. When back at the surface, a half-life of elimination of 90 minutes is used. So for example, if at the end of the dive the CNS was 80%, then 90 minutes later it will be 40%. In 90 more minutes it will be 20%, etc. Typically after about 6 half-life times (9 hours), everything is back close to equilibrium (0%).

TEMP
63°F

Temperature

Reports the temperature in degrees Celsius or Fahrenheit.

A digital display showing 'PPO2' in blue and '.36' in red on a black background.

PPO2 (average PPO2) FC DCC DCM

Only relevant when external PPO2 monitoring is used, since other modes already show PPO2 on the center row.

The purpose of this value is to show what PPO2 is actually being used for decompression calculations.

A digital display showing 'PPO2' in blue and '.16' in red on a black background.

When three external sensors are used, the NERD 2 votes on the three measured values to decide what is the most likely true PPO2. This value shows the result of the voting.

Also, when using external sensors and you have bailed out to OC, the center row continues to display the external measured PPO2. Use the average PPO2 display to see the OC PPO2.

In CC mode, average PPO2 displays in **Flashing Red** when less than 0.40 or greater than 1.6.

In OC mode, average PPO2 displays in **Flashing Red** when less than 0.19 or greater than 1.65.

A digital display showing 'DilPPO2' in blue and '.99' in white on a black background.

Diluent PPO2

Only displayed in CC mode. Displays in **Flashing Red** when the partial pressure of the diluent is less than 0.19 or greater than 1.65.

When performing a manual diluent flush, you can check this value to see what the expected PPO2 will be at the current depth.

A digital display showing 'FiO2' in blue and '.42' in white on a black background.

Fraction Inspired O2 (FiO2)

The fraction of the breathing gas composed of O2. This value is independent of pressure.

TISSUES BAR GRAPH



The tissues bar graph shows the tissue compartment inert gas tissue tensions based on the Bühlmann ZHL-16C model. Note that VPM-B also tracks tensions in the same way.

The fastest tissue compartment is shown on the top, and the slowest on the bottom. Each bar is the combined sum of the nitrogen and helium inert gas tensions. Pressure increases to the right.

The vertical black line shows the inert gas inspired pressure. The boundary between the green and yellow zones is the ambient pressure. The boundary between the yellow and red zone in the ZHL-16C M-Value pressure.

Note that the scale for each tissue compartment above the green zone is different. The reason the bars are scaled in this way is so that the tissues tensions can be visualized in terms of risk (i.e. how close they are as a percentage to Bühlmann's original supersaturation limits). Also, this scale changes with depth, since the M-Value line also changes with depth.

The video below demonstrates how to interpret the tissues bar graph on a Shearwater Petrel. The NERD 2's tissue bar graph is identical.



Watch the video:
[Tissues Demo](#)

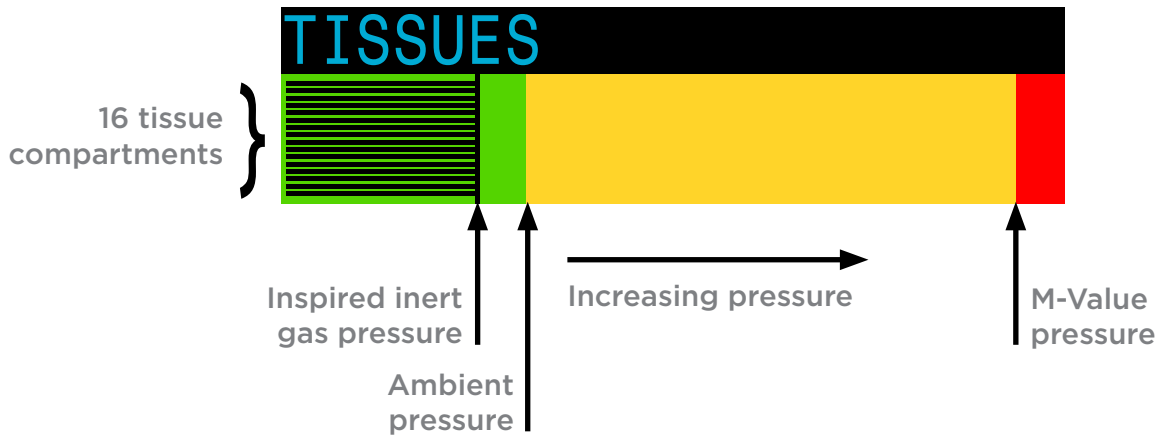

Sample Tissues Graphs



On surface (sat. with air)
Note: Gas is 79% N₂ (21% O₂, or Air)



After descent



On-gassing



Deep stop



Last deco stop
Note: Gas is now 50% O₂ and 50% N₂



A digital display showing 'GF' in cyan at the top right, '30' in white on the left, and '85' in white on the right, separated by a white slash.

Gradient Factor:

The deco conservatism value when the deco model is set to GF. The low and high gradient factors control the conservatism of the Bühlmann GF algorithm. For more information, see “Clearing up the Confusion About Deep Stops” by Erik Baker.



A digital display showing 'VPM-B' in cyan at the top, and '+3' in white below it.

VPM-B (and VPM-BG):

The deco conservatism value when the deco model is set to VPM-B.



A digital display showing 'VPM-BG' in cyan at the top, '+3' in white on the left, and '90' in white on the right, separated by a white slash.

If the deco model is VPM-B/GFS, also displays the gradient factor for surfacing.



A digital display showing 'PRESSURE mBar' in cyan at the top. Below it, 'SURF 1013' in white on the left and 'NOW 1011' in white on the right.

Pressure:

The pressure in millibars. Two values are shown, the surface (surf) pressure and the current (now) pressure.

The current pressure is only shown on the surface.

The surface pressure is set when the NERD 2 is turned on. If the Altitude setting is set to SeaLvl, then surface pressure is always 1013 millibars. Refer to “How Pressure is Set On the NERD 2”

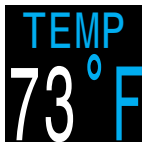

A digital display showing 'TEMP' in cyan at the top, '73' in white, and '°F' in cyan on the right.

Temperature:

The current temperature in degrees Fahrenheit or degrees Celsius. (Configure in Display Setup)

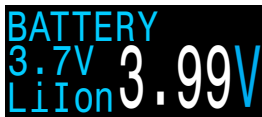

A digital display showing 'BATTERY' in cyan at the top. Below it, '3.7V' in white, 'LiIon' in cyan, and '3.99V' in white.

Battery:

The NERD 2’s internal battery voltage. Displays in **Yellow** when the battery is low and needs charging. Displays in **Flashing Red** when the battery is critically low and must be charged as soon as possible. The battery type is always Li-Ion for the NERD 2. A fully charged battery is 4.2V. The battery is critically low at 3.5V.

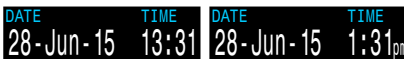

A digital display showing 'DATE' and 'TIME' in cyan at the top. Below it, '28-Jun-15' in white, '13:31' in white, '28-Jun-15' in white, and '1:31pm' in white.

Date and Time:

In the format dd-mon-yy
12 or 24 hour clock time.



A digital display showing 'SERIAL NO' in cyan at the top left and 'VERSION' in cyan at the top right. Below it, '1234ABCD' in white on the left and '2000029' in white on the right.

Serial Number & Version:

Each NERD 2 has a unique serial number.

The version number indicates the available features. The last two numbers are the firmware version (V29 in this image).

COMPASS

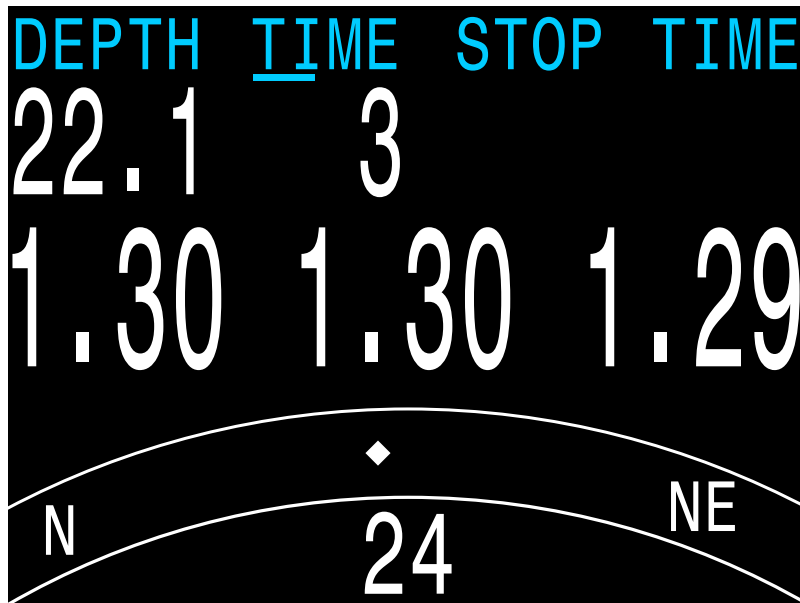

The NERD 2 contains a tilt-compensated digital compass in the eyepiece. The compass indicates the direction you are looking.

- ✔ Compass features:
- ✔ 1° resolution
- ✔ ±5° accuracy
- ✔ Smooth, high-speed refresh rate
- ✔ User set heading marker with reciprocal
- ✔ True North (declination) adjustment
- ✔ Tilt compensation Roll: ±45°, Pitch: ±135°

Viewing the Compass

When enabled, the compass is viewed by pressing the SELECT (right) button once. Press SELECT again to continue on to view the regular info screens.

Unlike the regular info screens, the compass never times out back to the main screen. Pressing the MENU (left) button brings up the Mark Heading option. Pressing MENU again returns to the main screen.

Tilt Compensation

Tilt compensation algorithms for digital compasses can typically only compensate well for up to $\pm 45^\circ$ of tilt on the pitch and roll axes. This is fine for roll, but when diving the pitch angle changes 90° as you move from being vertical in the water to being prone in a swimming position.

To compensate for this large pitch angle variation, the NERD 2 assumes that your direction heading shifts as you move from the vertical to prone position. When vertical, your direction is taken extending straight out your nose. When prone, your direction is taken as extending out the top of your head. Close to the switch-over point, both headings are averaged to prevent a discontinuity. The figure below illustrates this best.

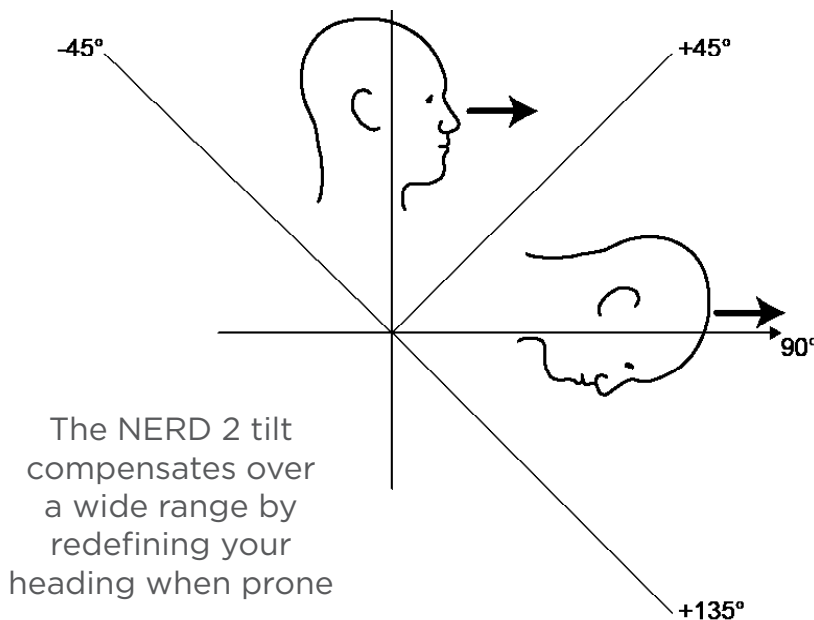

From -45° to $+45^\circ$ pitch, direction is taken facing forward.

From $+45^\circ$ to $+135^\circ$ pitch, direction is taken extending out the top of your head.

Outside these ranges, accuracy is not guaranteed.

Most divers will find this a natural way of interpreting direction.

A video demonstration of compass operation on the Petrel 2 dive computer can be found below. (operation is the same for NERD 2):

 **Watch the video:**
[Compass Features](#)

Marking a Heading

To mark a heading, when viewing the compass press the MENU (left) button. This brings up the "Exit Mark" menu. Press the SELECT (right) button to mark the heading.



The marked heading is shown with a green arrow. When within 35° of the heading, the degrees display turns green.



The reciprocal heading (180° from marked heading) is shown with a red arrow. When within 35° of the reciprocal heading, the degrees display turns red.

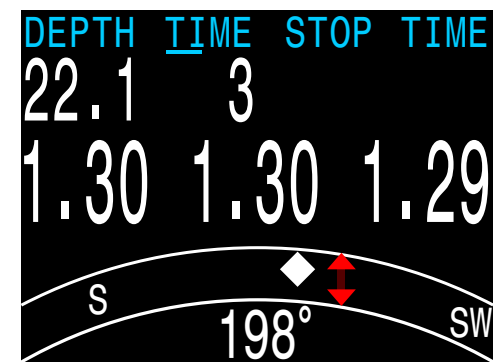

When more than 5° off the marked heading, a green arrow shows the direction back to the marked heading. Also, the offset degrees to the heading are displayed (16° in the example image). This offset is useful when navigating patterns. For example, a box pattern requires turns at 90° intervals, while a triangle pattern requires 120° turns.



COMPASS

It is important to understand some compass limitations before use.

Calibration:

The digital compass needs occasional calibration. This can be done in the [System Setup](#) → [Compass](#) menu and takes only one minute. See the compass Setup sub-section of the Menu Reference section of this manual for instructions on setting up and calibrating the compass.

Interference:

Metal objects, permanent magnets, and other sources of magnetic interference such as electric motors should be kept away from the compass. We recommend comparing the compass accuracy to a known good compass with and without the interfering object in place to see if it has an effect.

If a small metal object or magnet is attached in a fixed position relative to the eyepiece (i.e. it moves with the eyepiece), then this effect can be calibrated out using the Calibrate option in the Compass Setup menu.

Shipwrecks may interfere with the compass reading and so the compass function should not be used near or inside of a shipwreck. Use the same discretion and training as you would with a traditional compass.

Magnetic declination (also called magnetic variation) is the difference between magnetic and True North. This can be compensated in the Compass Setup menu. The magnetic declination varies around the world, so will need to be readjusted when travelling. This adjustment can also be used to compensate if the NERD 2 is mounted with a slight angle to your forward direction.

Magnetic inclination (or magnetic dip) is how much the Earth's magnetic field points up or down. The NERD 2 compass automatically compensates for this angle. However, in some locations (near the poles) the inclination angle can exceed 80° (i.e. the magnetic field points almost directly up or down), in which case the specified accuracy may not be met.

AIR INTEGRATION



All NERD 2 models are equipped with dual transmitter air integration capability*. For complete information on how to operate the various features of AI, see the [PERDIX AI Operating Instructions manual](#).

Features

- Wireless pressure monitoring of 1 or 2 scuba tanks.
- Units in PSI or Bar.
- Flexible display setup.
- Optional Gas Time Remaining (GTR) and Surface Air Consumption (SAC) rate based on one of the tanks.
- Logging of pressure, GTR, and SAC values at 10 second intervals.
- Average SAC of last dive displayed on surface.
- Warnings when reserve and critical pressures reached.
- Available in all modes
- Can be used to monitor O2 and diluent pressures in rebreathers



USE A BACKUP ANALOG SPG

Always use a backup submersible pressure gauge as a redundant source of gas pressure information.

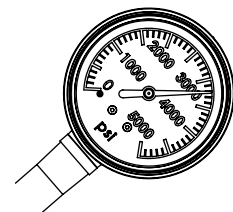

*Air Integration currently unavailable in EU

OPERATING MODES

The Mode setting allows tailoring the NERD 2 to specific types of diving.

Use the correct mode to get the best experience from the NERD 2.

The following modes are available:

Mode	Model Availability	Description
OC Rec	SA Fischer	Open Circuit Recreational
OC Tec	SA Fischer	Open Circuit Technical
CC/BO	SA Fischer DiveCAN Monitor DiveCAN Controller	Closed Circuit with Open Circuit bailout
SC/BO	Fischer	Semi-Closed Circuit with Open Circuit bailout
Gauge	SA Fischer	Depth and time display. No decompression.
PPO2	Fischer DiveCAN Monitor	Like Gauge but with PPO2 display. No decompression.

Each mode optimizes the main screen display and menu options for the specified style of diving.

See the Menu Reference->System Setup section for changing the mode.

Operating Modes (continued)

The following images show the main screen in each mode.

Mode Name	Main Screen	Mode Description
OC Rec		<p>Open Circuit Recreational</p> <p>Recreational Diving mode - Not covered by this manual. See: Recreational Nitrox Mode Manual</p>
OC Tec		<p>Open Circuit Technical</p> <p>Use when technical diving without a closed circuit rebreather. Simplifies operation by removing unneeded menus and displays.</p>
CC/BO		<p>Closed Circuit with OC bailout</p> <p>Can use either external PPO2 monitoring or fixed internal PPO2 setpoints.</p>
SC/BO		<p>Semi-closed Circuit with OC bailout</p> <p>Decompression is calculated differently in SC mode versus CC, because the projected PPO2 at shallower depths is different. Only external PPO2 monitoring is available.</p>

(Continued on next page)

Operating Modes (continued)

Mode Name	Main Screen	Mode Description
Gauge		<p>A simple bottom timer. No decompression displays. With large depth and time including seconds. Stopwatch function plus resettable average depth.</p>
PPO2		<p>A simple bottom timer that also shows external measured PPO2. No decompression displays. With large depth and time including seconds. Stopwatch function plus resettable average depth.</p>

GAUGE MODE

Gauge Mode turns the NERD 2 into a simple depth and time display (a.k.a. a bottom timer).

Change to Gauge Mode in the [System Setup](#) → [Dive Setup](#) menu.

Since decompression tissues are not tracked in Gauge Mode, changing to or from Gauge Mode resets the deco tissues.

Features:

- Extra-Large Depth Display (in feet or meters)
- Extra-Large Time Display (in minutes:seconds)
- Maximum and Average Depth on main screen.
- Stopwatch
- Resettable Average Depth

The Gauge display is organized as:

- Depths along the left.
- Times along the right.
- Most important information (Depth, Dive Time) on the top row.

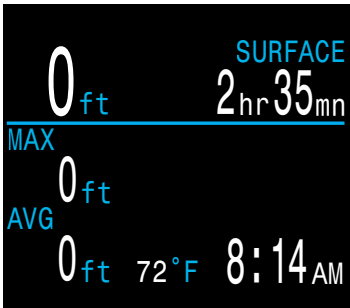

Gauge - Surface Display



Gauge - Dive Display



Stopwatch Running

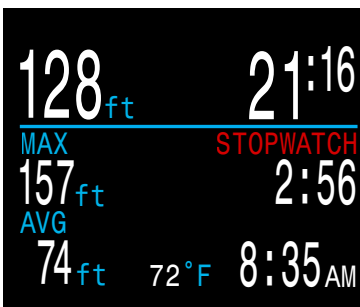

Stopwatch Stopped

STOPWATCH

When diving, starting or stopping the Stopwatch is the first menu option.

When stopped, the word “Stopwatch” displays in red.

When non-zero, the stopwatch can be reset. Reset behavior depends on state:

- If running when reset, it continues running, counting up again from 0.
- If stopped when reset, then it is set 0 and remains stopped.

RESETTABLE AVERAGE DEPTH

During a dive, the average depth can be reset.

While on the surface, the MAX and AVG values display the maximum and average depth of the last dive. The AVG depth displayed on the surface is for the entire dive, regardless of whether the reset average depth option was used. The dive log also records the average depth for the entire dive.

SIMPLE OC EXAMPLE DIVE

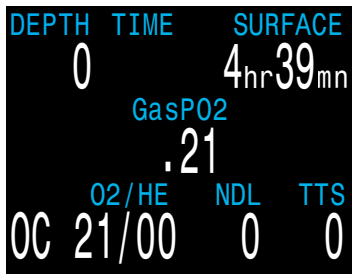

Here is an example of a simple OC air dive. It will help to introduce the screen displays as the diver progresses, the dive starts, the depth increases. The display is showing the computer programmed for open circuit (OC) air.

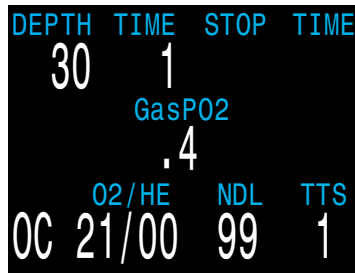

As we pass through 30 feet, the time-to-surface (TTS) shows one minute. This shows that the computer is expecting the diver to ascend at approximately 33 feet per minute or 10 meters per minute. The dive predictions are based on this ascent rate.



The no-decompression limit (NDL) starts off showing 99, but then starts to show a smaller number as the depth increases. The 3rd screen shows that we will go into deco in 12 minutes.



We have now entered decompression. Our first stop is at 20 feet and we will need to remain there for up to one minute. Although stops are shown in minutes, the computer will calculate and change the ceiling in real time and the stop may be less than a minute.



As we ascend, the ascent rate indicator shows about 20 fpm or 6 mpm.

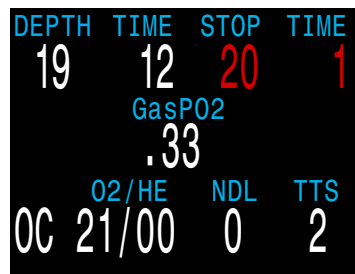

When we go shallower than our first stop, the stop depth starts to flash red.

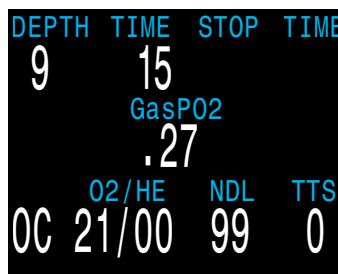

When we clear the last stop, the stop depth and time goes blank, and now we see a NDL of 99 minutes again. Once we surface, the depth is 0 and a minute later when the computer comes out of dive mode, the NDL goes to 0 as well.

An example dive performed on the Shearwater Petrel can be found here:

Watch the video:
[Air - Dive](#)

SIMPLE CC EXAMPLE DIVE

Here is an example of a simple CC dive. The display is showing the computer at the surface, programmed for closed circuit mode (CC). The diluent is set to air (21/00).

Typically a PPO2 setpoint of 0.7 will be used at the surface.

DEPTH	TIME	SURFACE	
0		2hr15mn	
.70	.71	.70	
	O2/HE	NDL	TTS
CC	21/00	0	0

Once the descent has started the NERD 2 will change to dive mode.

In dive mode dive time starts counting and the surface interval display changes to stop depth and time.

DEPTH	TIME	STOP	TIME
37	1		
.88	.88	.89	
	O2/HE	NDL	TTS
CC	21/00	99	2

At the bottom the NDL is showing that we have 11 minutes at this depth until decompression stops will be needed. The PPO2 of the three externally monitored cells has increased. No decompression stops are yet required, so the TTS of 4 minutes is the time to ascend directly to the surface at 33 ft/min.

DEPTH	TIME	STOP	TIME
125	7		
1.30	1.31	1.29	
	O2/HE	NDL	TTS
CC	21/00	11	4

After a few more minutes, the remaining no-decompression limit (NDL) time has dropped below 5 minutes, and is now highlighted in **yellow**.

DEPTH	TIME	STOP	TIME
125	15		
1.30	1.31	1.29	
	O2/HE	NDL	TTS
CC	21/00	3	4

Once the NDL hits 0, deco stops will be needed. Stop requirements display in the top-right corner.

Also, note that the NDL location is now displaying additional info, in this case @+5.

TTS has increased to include deco stop time..

DEPTH	TIME	STOP	TIME
122	42	40	2
1.30	1.31	1.29	
	O2/HE	@+5	TTS
CC	21/00	26	22

(Continued on next page)

Simple CC Dive Example (continued)

It is safe to ascend to 40ft. 2 minutes must be spent at this deco stop.
 While ascending, the bar graph to the right of the depth shows the ascent rate.
 Each bar indicates 10 ft per minute (3m/min) of ascent rate.

DEPTH	TIME	STOP	TIME
82	44	40	2
1.30	1.31	1.29	
	O ₂ /HE	@+5	TTS
CC	21/00	24	21

Stay at each stop depth until it clears.

DEPTH	TIME	STOP	TIME
41	46	40	1
1.32	1.31	1.30	
	O ₂ /HE	@+5	TTS
CC	21/00	23	20

If you ascend shallower than the stop depth, the display will alert you with **red** deco stop text and a **yellow** warning.

Acknowledge and clear the warning by pressing the SELECT button.

Re-descend deeper than the stop depth to clear the flashing red text.

DEPTH	TIME	STOP	TIME
17	52	20	3
1.28	1.30	1.28	
Error		CONFIRM	
MISSED	DECO	STOP	

Once all the deco stops have cleared, you can ascend to the surface to end the dive.

DEPTH	TIME	STOP	TIME
11	65	Deco Clear	
1.26	1.25	1.26	
	O ₂ /HE	NDL	TTS
CC	21/00	99	1

COMPLEX CC DIVE EXAMPLE

The following is a more complex rebreather dive that includes dive-planning and multi-gas OC bailout.

Diluent: Trimix (10/50)	Bailout gases: 10/50, 21/00, and 50/00
Max Depth: 90 meters for 20 minutes	Metric units (meters) are used

Dive Phase	Description	NERD 2 Display
Setup CC Gases	Best practices include checking your gas lists before each dive. This screen is available in the System Setup menu. For this dive the only CC diluent is trimix 10/50 (10% O2, 50% He, 40% N2).	
Setup OC Bailout Gases	For the OC bailout gas list, several gases are needed. We will verify that we are carrying enough of each gas when we plan the dive.	
Verify Settings	It is also prudent to ensure all other settings are correct before starting the dive. Although gases and some settings can be changed underwater, it is best to have them right from the start.	
Plan Dive & Bailout	Use the dive planner to check the total runtime, decompression schedule and bailout gas quantity needed. For CC dives, both the closed-circuit (CC) and bailout (BO) plans are displayed. The bailout plan also includes how much gas is needed. The on-board deco planner is limited in functionality, so for complex dives we recommend planning using desktop or smartphone dive planning software.	

(Continued on next page)

Complex CC Dive Example (continued)

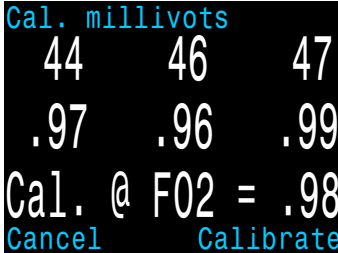
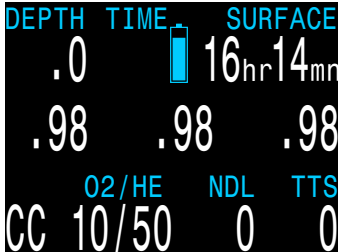
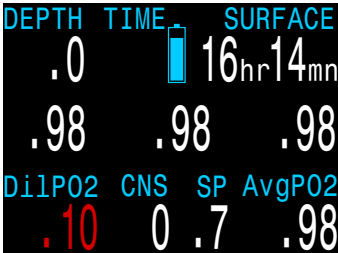
Dive Phase	Description	NERD Display
PPO2 Calibration	<p>If the PPO2 sensors need calibration, follow the instructions from your rebreather manufacturer.</p> <p>On the PPO2 calibration screen, the top row displays the millivolt (mV) reading from each sensor. The middle row is the current PPO2 (from the last calibration). The bottom row shows the fraction of oxygen setting.</p> <p>After calibration completes a results screen will be displayed. Note that the PPO2 might not match the FO2 exactly, due to the ambient pressure not being exactly 1 ata.</p>	 <pre> Cal. millivots 44 46 47 .97 .96 .99 Cal. @ FO2 = .98 Cancel Calibrate </pre>
Ready to Dive	<p>The dive is now ready to begin.</p>	 <pre> DEPTH TIME SURFACE .0 [] 16hr14mn .98 .98 .98 O2/HE NDL TTS CC 10/50 0 0 </pre>
Note on Hypoxic Diluents	<p>Hypoxic diluents such as the 10/50 in this example require special training since they can be deadly near the surface. Pressing SELECT brings up the first info screen which shows the diluent PPO2. The red indicates it is unsafe to breathe directly.</p> <p>You can view this info at any time to verify that the diluent is safe or to check what the expected PPO2 will be when flushing with diluent at depth.</p>	 <pre> DEPTH TIME SURFACE .0 [] 16hr14mn .98 .98 .98 DilPPO2 CNS SP AvgPPO2 .10 0 .7 .98 </pre>



(Continued on next page)

Complex CC Dive Example (continued)

Dive Phase	Description	NERD 2 Display
Decreasing NDL	As we descend, the NDL decreases. The TTS shows it will take 5 minutes to ascend to the surface at 10m/min (33ft/min).	<pre> DEPTH TIME STOP TIME 48.4 3 1.30 1.30 1.29 O2/HE NDL TTS CC 10/50 4 5 </pre>
Bottom Time	We have now completed the bottom time. The TTS indicates we have about 1.5 hours (92 minutes) of decompression to do. The first stop will be at 48m for 1 minute.	<pre> DEPTH TIME STOP TIME 90.2 20 48 1 1.30 1.30 1.29 O2/HE GF99 TTS CC 10/50 On Gas 92 </pre>
Ascending to First Stop	Here we are ascending at 3m/min (each bar beside the depth is 3m/min). This is slower than the expected 10m/min ascent rate. This slow ascent has caused the TTS to rise, as most tissues are still on-gassing.	<pre> DEPTH TIME STOP TIME 61.6 29 48 1 1.29 1.28 1.29 O2/HE GF99 TTS CC 10/50 6% 96 </pre>
First Deco Stop	The slow ascent has caused the first stop to clear before we reached it. This often happens with slow ascents. Note that the GF99 value now indicates that the leading tissues are now off-gassing. However, at this deep depth most tissue compartments are still on-gassing.	<pre> DEPTH TIME STOP TIME 45.3 34 45 1 1.30 1.32 1.31 O2/HE GF99 TTS CC 10/50 20% 98 </pre>
A problem has developed	The yellow cell reading is disagreeing with the other two. A flush with diluent has shown that the lone low cell is actually correct. It is decided to bailout to open circuit.	<pre> DEPTH TIME STOP TIME 30.4 42 30 2 .41 1.05 1.08 O2/HE GF99 TTS CC 10/50 45% 89 </pre>

(Continued on next page)

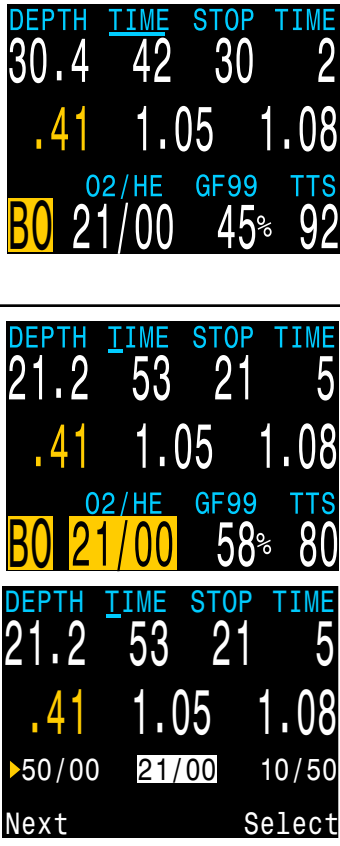
Complex CC Dive Example (continued)

Dive Phase	Description	NERD 2 Display
Bailout	<p>After physically switching the BOV or mouthpiece, the computer needs to be set to BO mode for proper deco calculations.</p> <p>Two presses on MENU brings up the "SWITCH CC -> BO" menu. Pressing SELECT makes the change.</p> <p>Note that the loop PPO2 continues to display. This is important in case the diver later needs to go back onto the loop. Also note that "BO" is displayed in yellow to indicate the bailout condition.</p> <p>The best BO gas was automatically selected, and the deco schedule has been adjusted based on the BO gases.</p>	 <p>DEPTH TIME STOP TIME 30.4 42 30 2 .41 1.05 1.08 Switch CC -> BO</p>
Switch Gas	<p>We are now at 21m, having completed a few more deco stops. The gas is now displaying in yellow, indicating a better gas is available.</p> <p>Pressing MENU twice brings up the "SELECT GAS" menu, and pressing SELECT enters it. With the "new style" gas select menu, the best gas will already be the initial selection, just press SELECT to make it the active gas.</p> <p>If using the "old style" gas select menu, see the gas select section for instructions.</p>	 <p>DEPTH TIME STOP TIME 30.4 42 30 2 .41 1.05 1.08 O2/HE GF99 TTS BO 21/00 45% 92</p> <hr/> <p>DEPTH TIME STOP TIME 21.2 53 21 5 .41 1.05 1.08 O2/HE GF99 TTS BO 21/00 58% 80</p> <hr/> <p>DEPTH TIME STOP TIME 21.2 53 21 5 .41 1.05 1.08 ▶50/00 21/00 10/50 Next Select</p>
Deco Clear	<p>Follow the deco stops until they have all cleared. Now it is time to ascend and end the dive.</p> <p>End of example.</p>	 <p>DEPTH TIME STOP TIME 3.1 132 Deco Clear .22 .82 .85 O2/HE GF99 TTS BO 50/00 72% 1</p>

DECOMPRESSION AND GRADIENT FACTORS

The basic decompression algorithm used for the computer is Bühlmann ZHL-16C. It has been modified by the use of Gradient Factors that were developed by Erik Baker. We have used his ideas to create our own code to implement it. We would like to give credit to Erik for his work in education about decompression algorithms, but he is in no way responsible for the code we have written.

The computer implements Gradient Factors by using levels of conservatism. The levels of conservatism are pairs of number like 30/70. For a more detailed explanation of their meaning, please refer to Erik Baker's excellent articles: **Clearing Up The Confusion About "Deep Stops"** and **Understanding M-values**. The articles are readily available on the web. You might also want to search for "Gradient Factors" on the web.

The default of the system is 30/70. The system provides several settings that are more aggressive than the default.

Don't use the system until you understand how it works.

Graph from Erik Baker’s “Clearing Up The Confusion About Deep Stops”

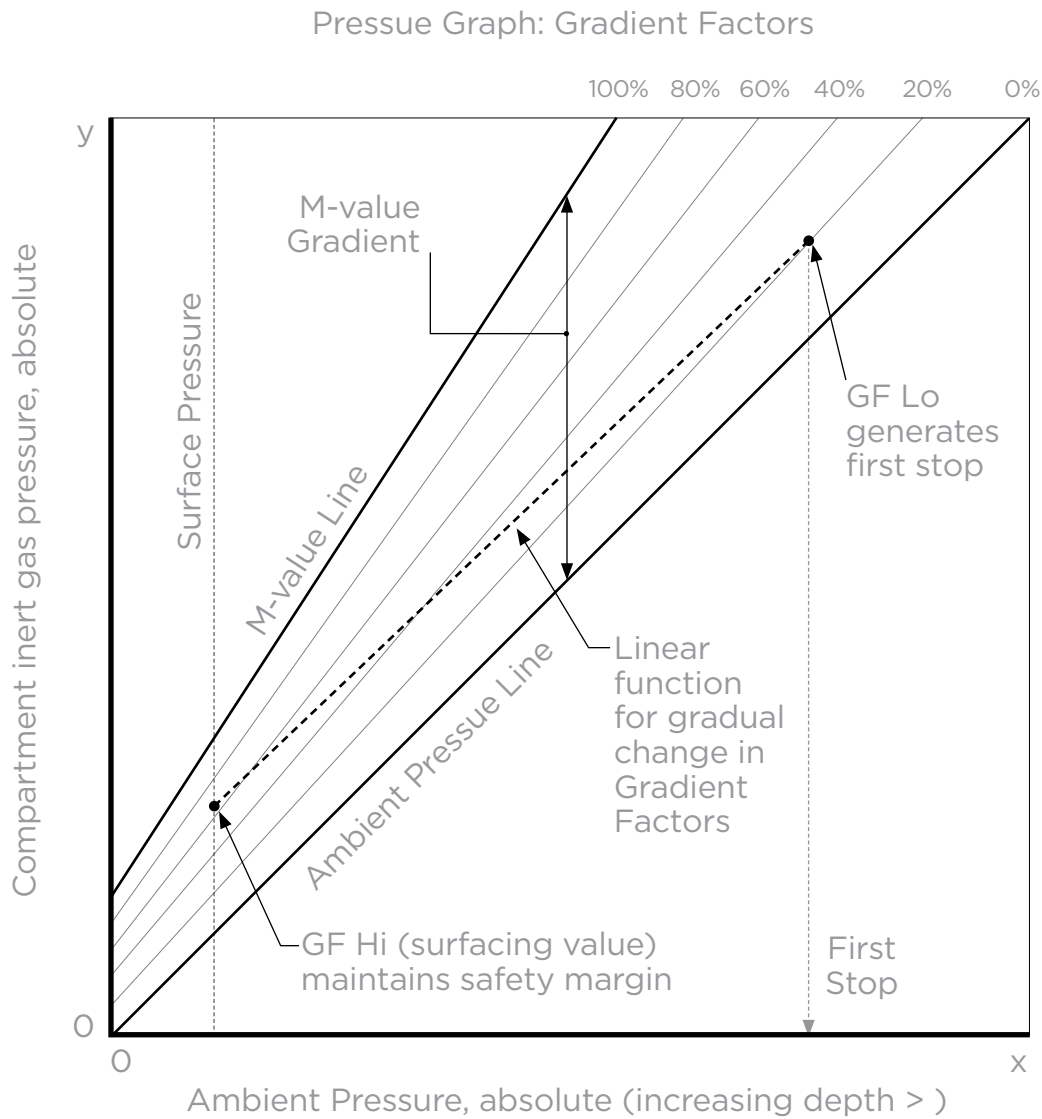

- A Gradient Factor is simply a decimal fraction (or percentage) of the M-value Gradient.
- Gradient Factors (GF) are defined from 0% to 100%.
- A Gradient Factor of 0% represents the ambient pressure line.
- A Gradient Factor of 100% represents the M-value line.
- Gradient Factors modify the original M-value equations for conservatism within the decompression zone.
- The lower Gradient Factor value (GF Lo) determines the depth of the first stop. Used to generate deep stops to the depth of the "deepest possible deco stop"

MENUS



Press MENU (left) button to step through the menus.

Press SELECT (right) button to execute command or enter sub-menu.

Menus display on the bottom row.

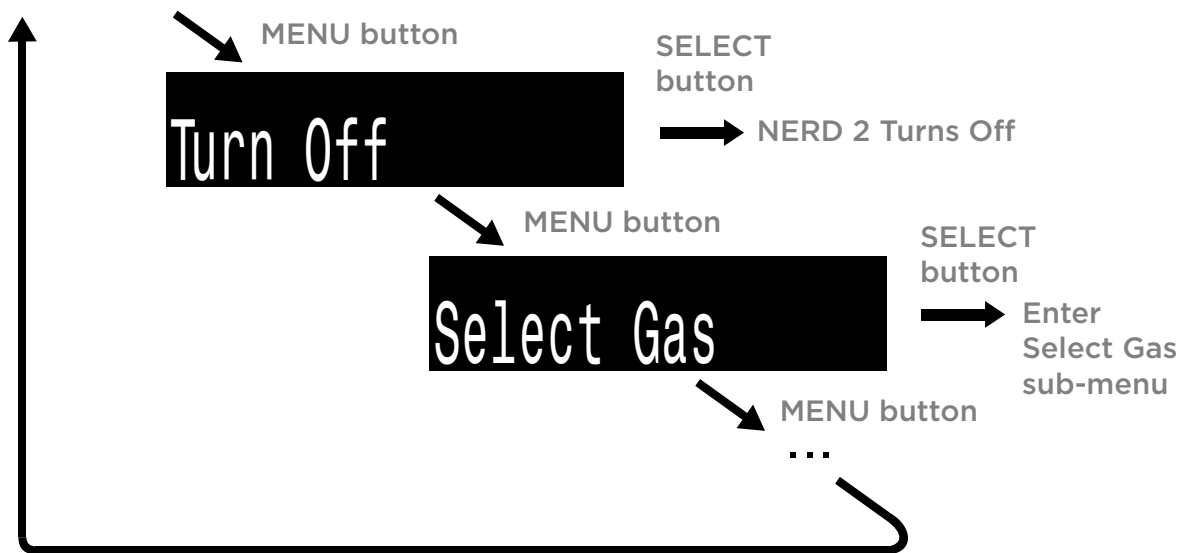

Menus perform actions and allow settings to be changed.

Starting from the main screen, pressing the MENU (left) button steps through the menus. When all menus have been viewed, pressing MENU again will return to the main screen.

Pressing the SELECT (right) button when a menu is displayed, either performs that action or enters a sub-menu.

If no buttons are pushed for 1 minute, the menu system will time-out, returning to the main screen. Anything that had been previously saved will be retained. Anything that was in the middle of editing will be discarded.

i ADAPTIVE MENUS

Only menus necessary for the current mode are shown. This keeps operation simple, prevents mistakes, and reduces buttons presses.

The following sections show the menu structure in various operating modes.

OC TEC MENU STRUCTURE

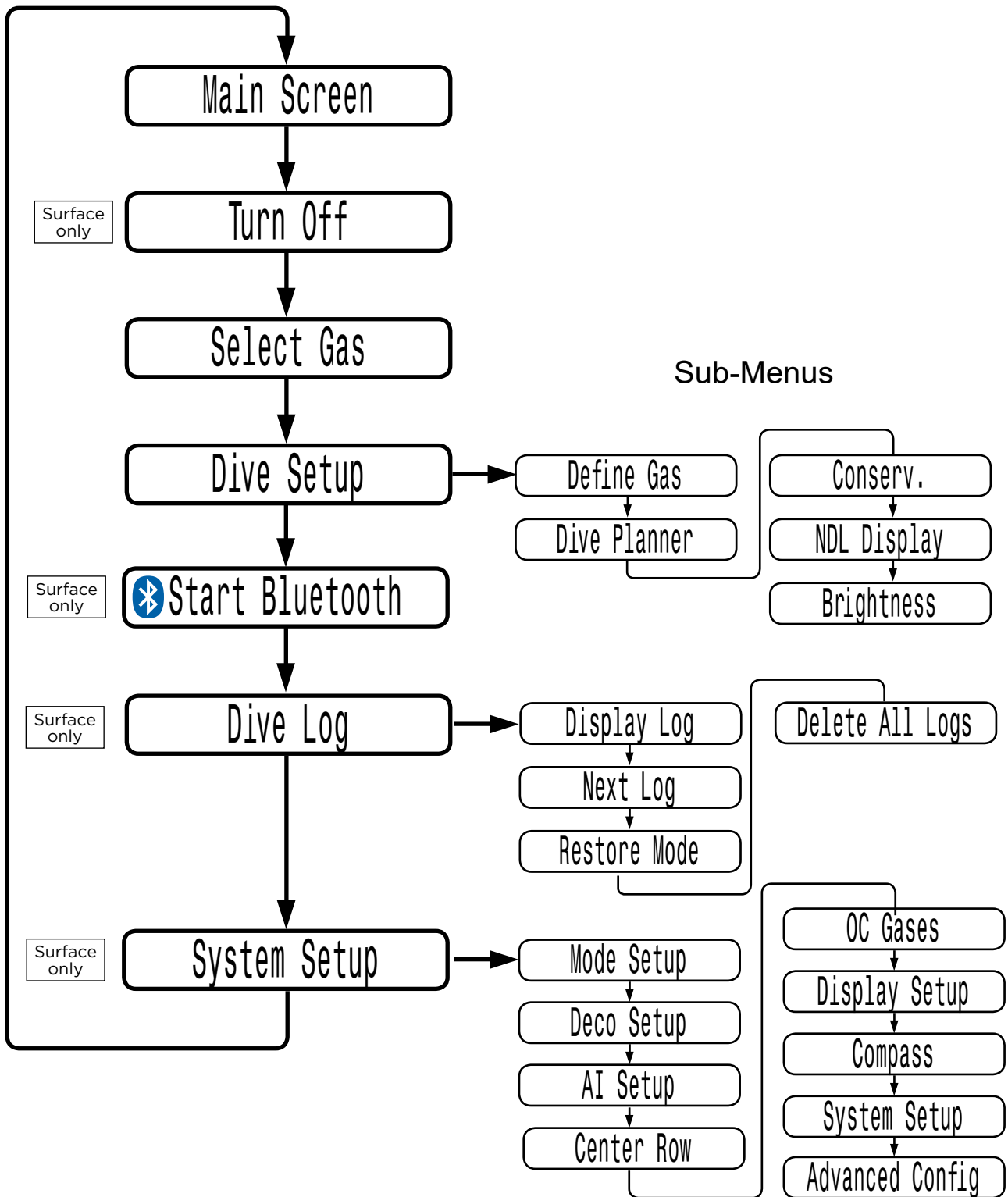

CLOSED CIRCUIT (INT. PPO2) MENU STRUCTURE

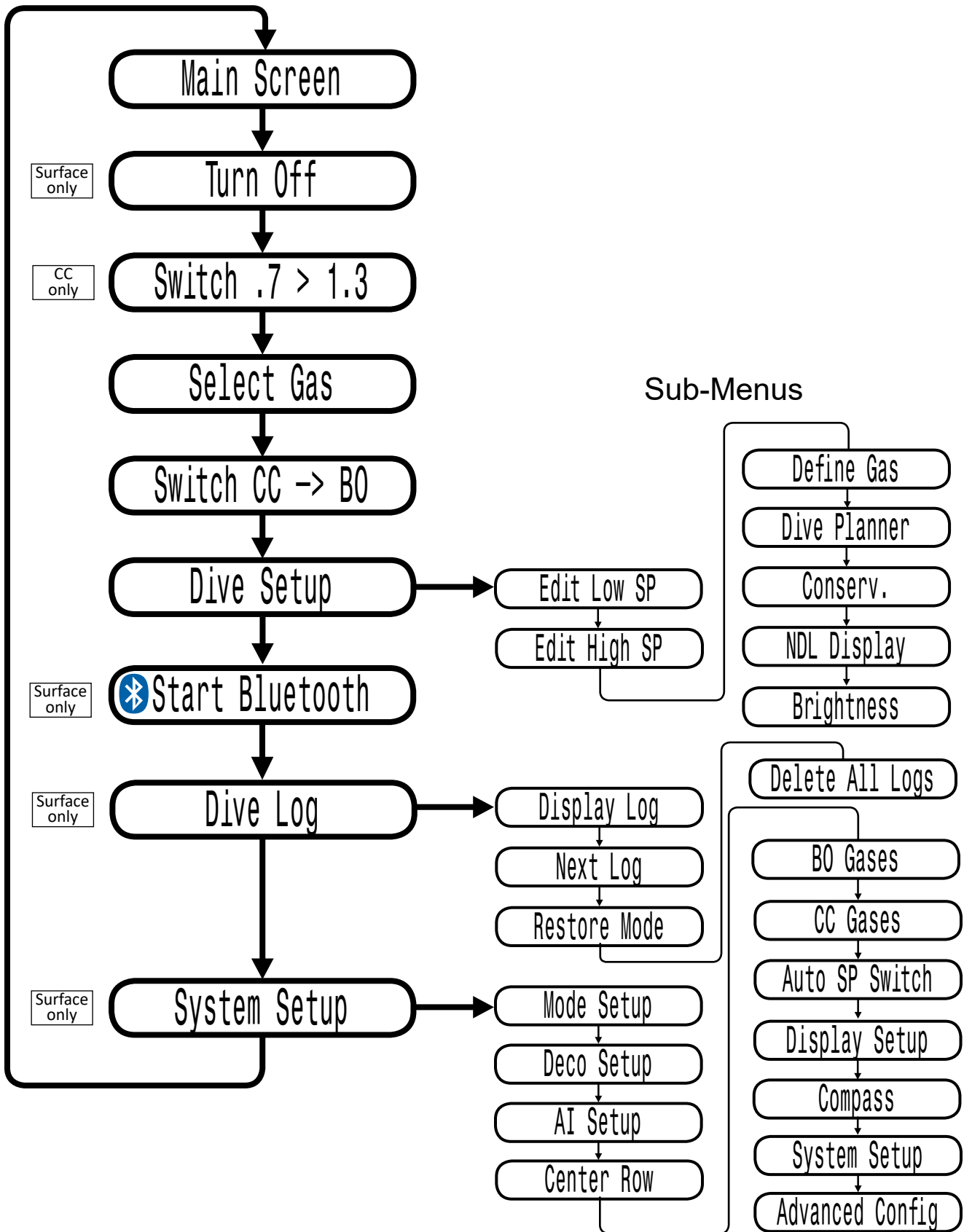

CLOSED CIRCUIT (EXT. PPO2) MENU STRUCTURE

FC DCC DCM

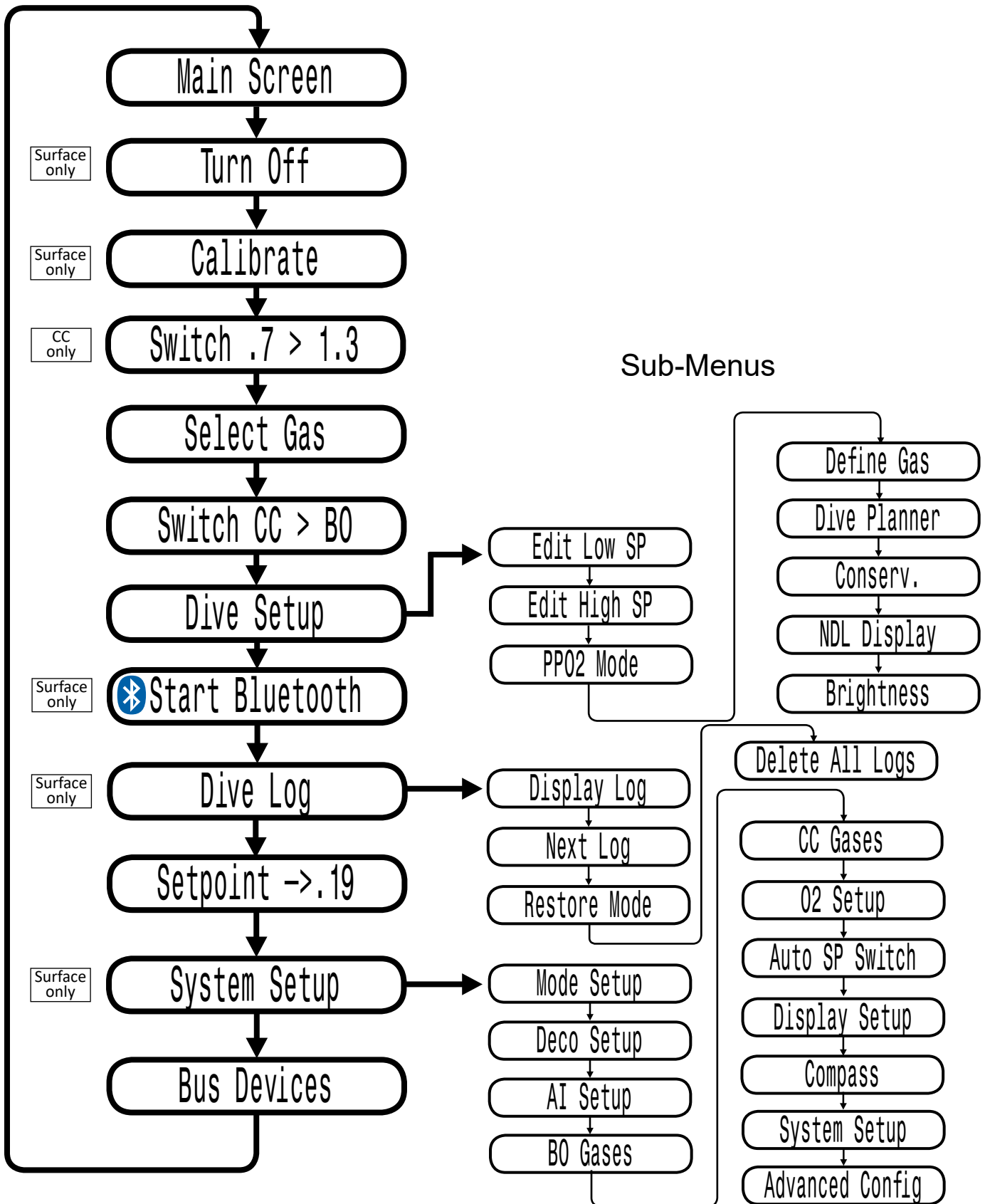

GAUGE MENU STRUCTURE

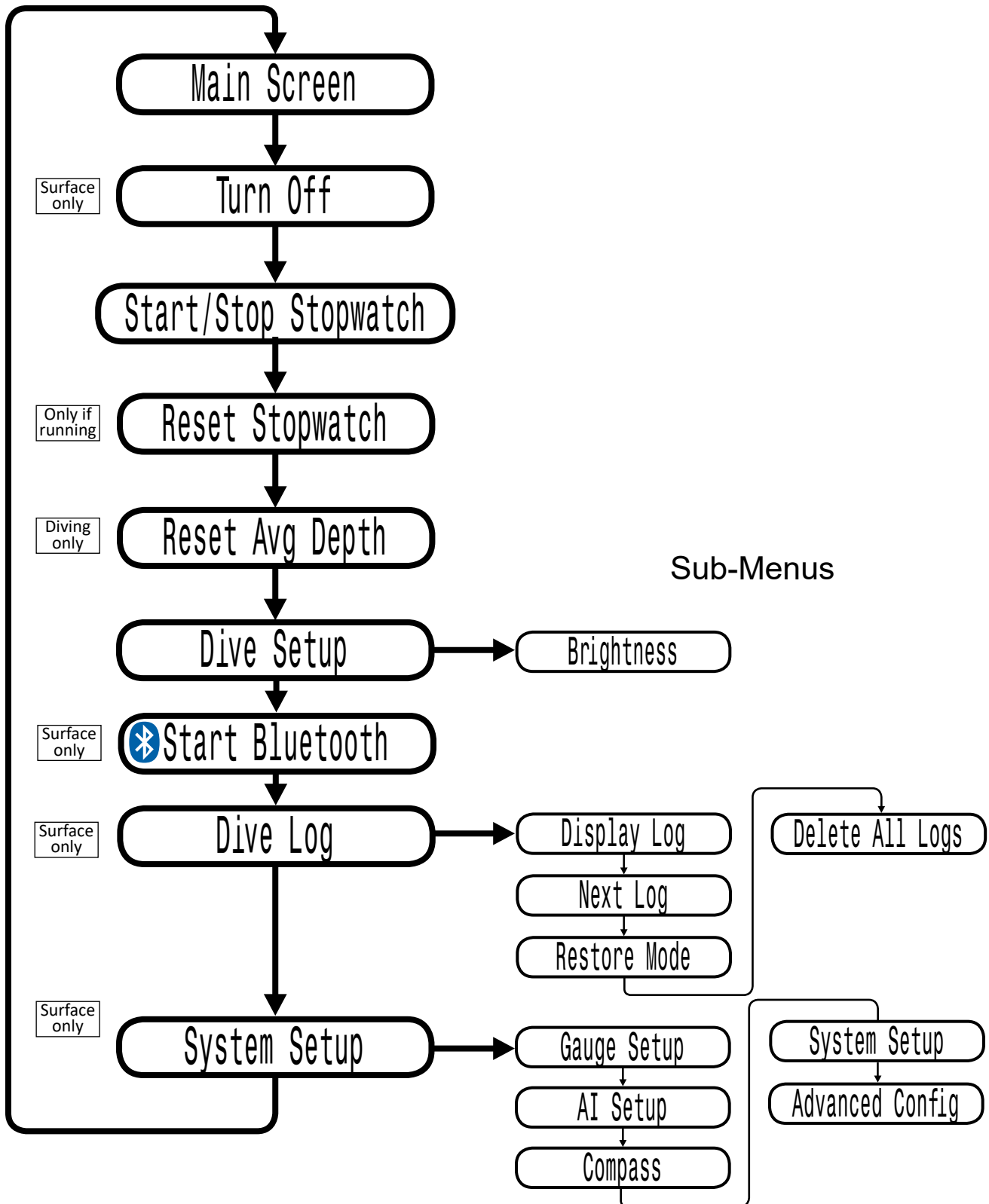

MENU REFERENCE

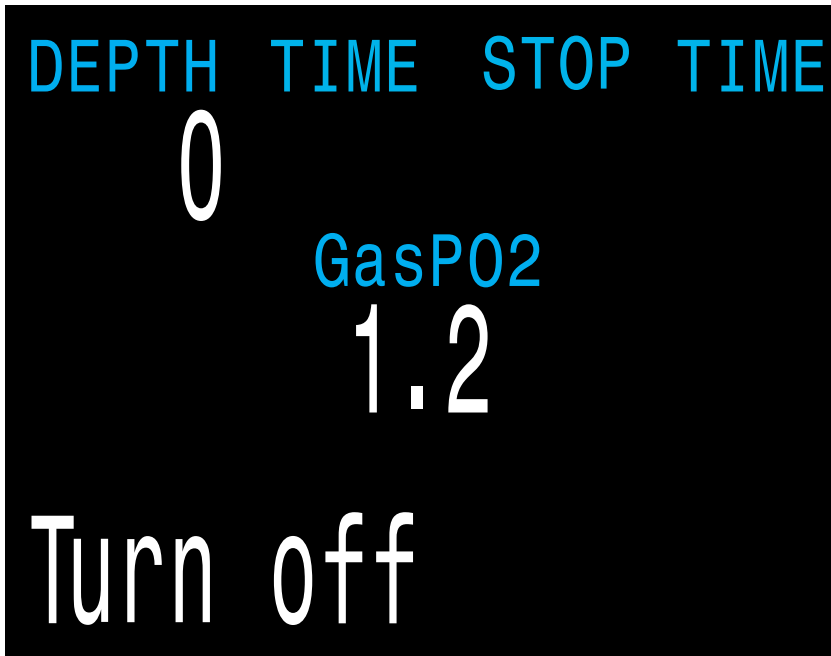

TURN OFF

The “Turn Off” item puts the computer to sleep. While sleeping, the screen is blank, but the tissue contents are maintained for repetitive diving. The “Turn Off” menu item will not appear during a dive on any model. It will also not appear after a dive until the **End Dive Delay** Time has expired to allow for a continuation dive.

CALIBRATION FC DCC DCM

The Calibrate menu will only appear when in CC mode with the PPO2 mode set to Ext. This menu calibrates the mV output from the oxygen sensors to PPO2.

Upon selecting the calibration menu, the screen will show:

Top row:

Millivolt (mV) readings from the 3 O2 sensors.

Middle row:

PPO2 values (using the previous calibration).

Bottom row:

The calibration gas fraction of O2 (FO2).

If you need to change the calibration gas FO2, do this in the System Setup O2 Setup menu.

After flooding the breathing loop with the calibration gas (typically pure oxygen), press the SELECT button to perform the calibration.

Good sensors should be in the range of 35 - 65 mV at sea level in 100% oxygen, so a sensor will fail calibration if not in the range of 30mV to 70 mV. This allowable range scales automatically with changes to FO2 and barometric pressure. A millivolt reading is shown in **yellow** if outside the allowable range.

Once the calibration completes, a report will be shown. This shows which sensors passed calibration, and the value of the expected PPO2 based on barometric pressure and the FO2.

Back at the main screen, the displays should now all read the expected PPO2. For example, if FO2 is 0.98 and barometric pressure is 1013 mbar (1 ata), then PPO2 will be 0.98. If any display shows **FAIL**, the calibration has failed because the mV reading is out of range.

The “Calibrate” menu item will not display during a dive.

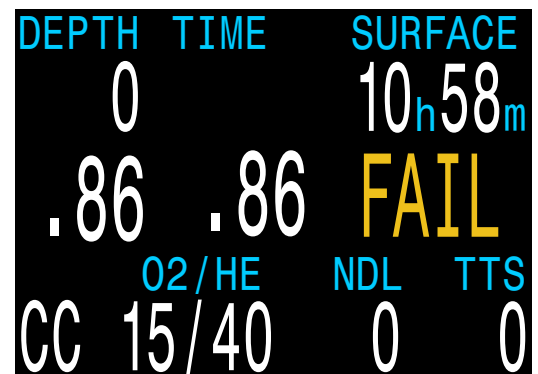
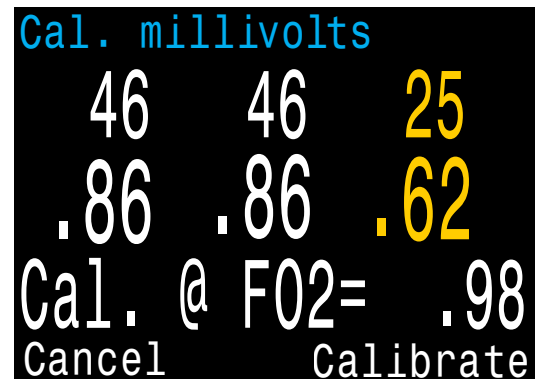

SINGLE SENSOR MODE FC DCM

A single external O2 sensor may be used.

To enter this mode, perform the calibration with only the middle sensor connected (sensor #2).

The NERD will see that only one sensor is connected, and automatically switch to single sensor mode.



DUAL SENSOR MODE FC DCM

External PPO2 monitoring is also supported for 2 sensors.

Access the 2 sensor mode by performing a PPO2 calibration with only sensors #1 and #2 connected.

When using the 2 sensor mode, a configurable value may be displayed on the right side of the screen.

Voting Passed

If the sensors are within 20%, voting passes and the average PPO2 of the two sensors is used for decompression and CNS calculations.

Voting Failed

If the two sensors differ by more than 20%, voting has failed.

Failed sensors are shown in **yellow** (unless below 0.4 or above 1.6, then they will be shown in **red**).

PPO2 display will alternate with the message "VOTING FAILED".

The lower PPO2 value will be used for decompression calculations.

The higher PPO2 value will be used for CNS calculations.

CALIBRATION PROBLEMS FC DCC DCM

One sensor displays FAIL after calibration

This could indicate a bad sensor. It has failed because the mV output was not in range. The sensor could be old or damaged, and should be inspected. Damage and corrosion to wires or connectors is also a common problem. Fix the problem and recalibrate before diving.

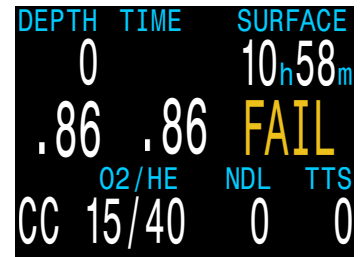

All sensors display FAIL after calibration

This could be caused by an accidentally unplugged cable or a damaged cable or connector. Also, accidentally performing the calibration in air or without a proper oxygen flush could cause this problem. A failed calibration can only be fixed by performing a successful calibration.



PPO2 does not show 0.98 after calibration

If you use a calibration FO2 setting of 0.98 and are at sea level, you probably expect the calibrated PPO2 to show 0.98. Sometimes you might correctly get a different value like 0.96 or 1.01.

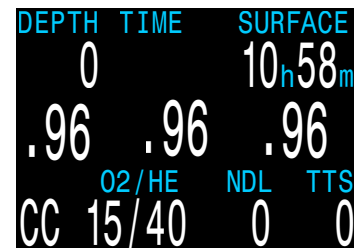

This is because weather causes minor changes in barometric pressure. For example, say a low-pressure weather system has reduced the normal (1013mbar) barometric pressure to 990mbar. The PPO2 in absolute atmospheres is then $0.98 * (990/1013) = 0.96$.

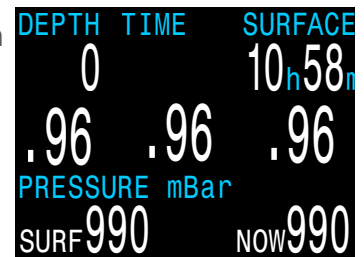

The 0.96 PPO2 result is, in this case, correct. At high altitudes, the difference between FO2 and PPO2 will be even larger. To see the current pressure, start at the main screen and press the SELECT button a few times (displays as Pressure mBar NOW).

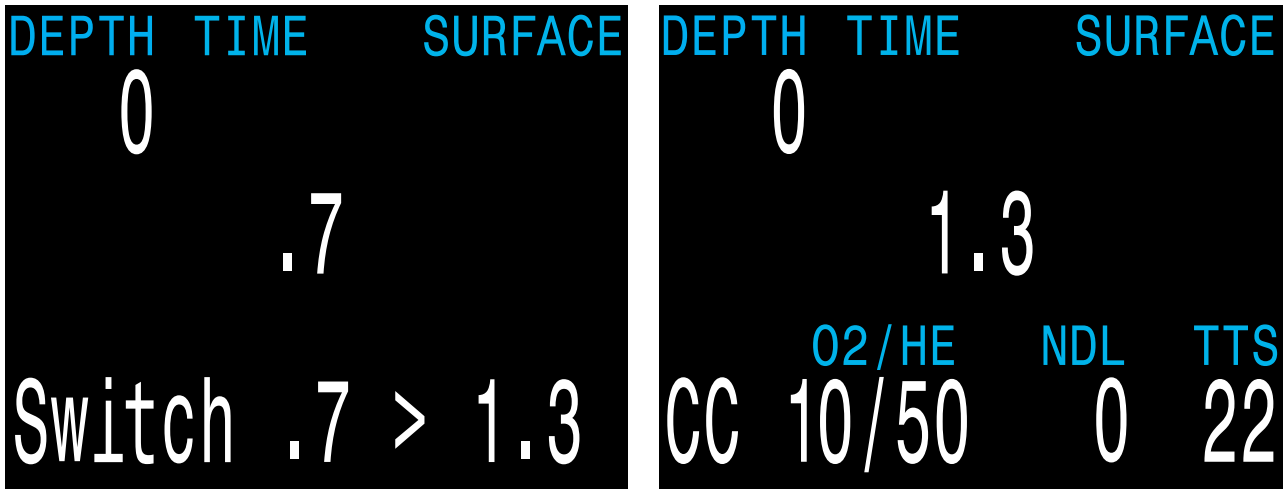

SWITCH SETPOINT

This menu is only available under two conditions:

1. In CC mode when PPO2 is set to int (internal).
2. When using a DiveCAN controller model.

When using the internal PPO2 stand alone mode, this set point is used to calculate decompression for a unconnected rebreather. In this case, the setpoints are switched in the computer to approximate the rebreather setpoint.

When using a rebreather controller model, this set point instructs the solenoid controller on the PPO2 to regulate. In this case, decompression calculations are based on actual measured PPO2.

During a dive the “Switch Setpoint” menu item will be the first item displayed, since the “Turn Off” and “Calibrate” displays are disabled when diving.

Pressing SELECT when this menu is displayed changes the PPO2 setpoint from the low setpoint to the high setpoint or vice-versa. To redefine the PPO2 value of a setpoint, use the Dive Setup menu.

This menu item performs a manual switching of PPO2 setpoint. In the [System Setup](#) → [Auto SP Switch](#) menu, the NERD 2 can be setup to automatically perform setpoint switches at programmable depths. When auto setpoint switches are enabled, this menu item is still available to provide manual control.

SELECT GAS

This menu item allows you to pick a gas from the gases you have created. The selected gas will be used either as the breathing gas in open circuit mode, or the diluent in closed circuit mode.

Gases are always sorted from most to least oxygen content.

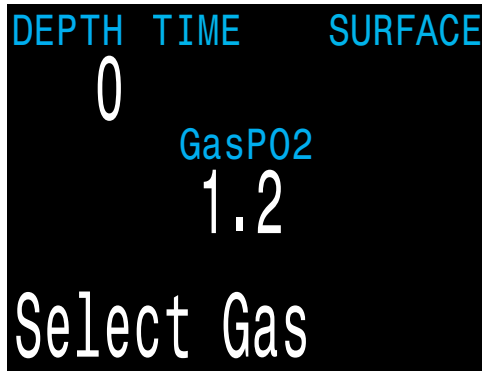

Use the MENU button to increment to the desired diluent/gas, then press the SELECT button to select that diluent/gas.

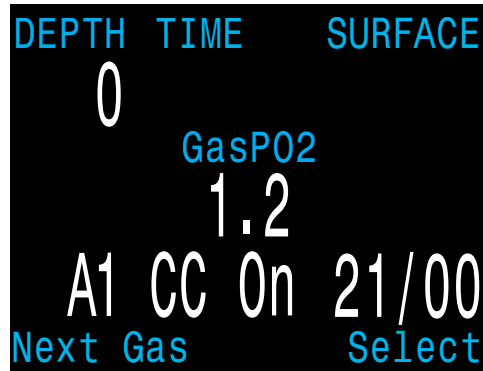

If you increment past the number of gases available, the display will fall back out of the “Select Gas” display without changing the selected gas.

An ‘A’ will appear next to the currently active gas.

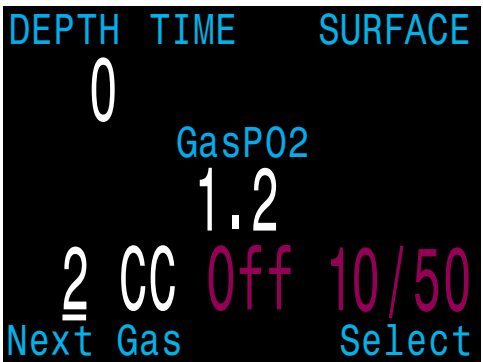
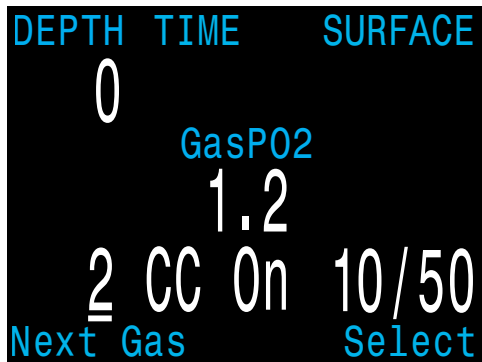

A gas that is off will be shown in **Magenta**, but can still be selected. It will be turned on automatically if it is selected. Off gasses are not used in decompression calculations.

Off gases are not used in decompression calculations.



Radio Station Gases

For computer models that support open circuit and closed circuit operation, the system maintains two sets of gases - one for open circuit and one for closed circuit.

The way they operate is very similar to the way car radios work with AM and FM stations.

When you are listening to an FM station and you push a station selection button, it will take you to another FM station. If you add a new station, it will be an FM station.

Similarly, if you are in the AM mode, adding or deleting a station would add or delete an AM station.

With radio station gases, when you are in open circuit, adding, deleting or selecting a gas will refer to an open circuit gas. Just like the FM stations are selected when your radio is in FM mode, the closed circuit gases are available in the closed circuit mode. When you switch to open circuit, the gases available will be open circuit gases.

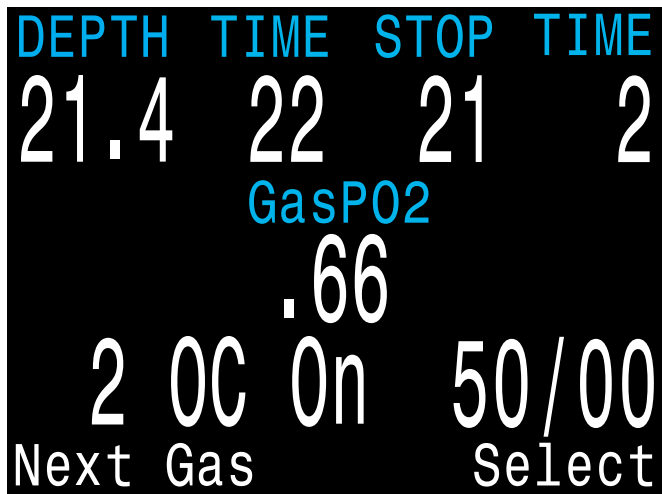
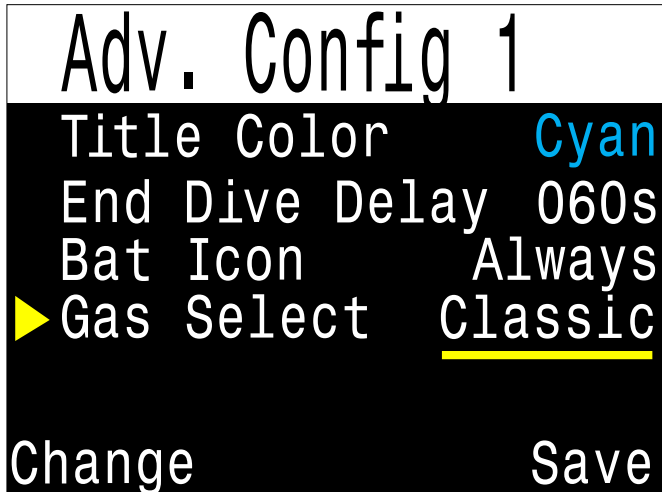

Classic Select Gas

SELECT GAS MENU STYLES

Two styles of Select Gas menus are available, Classic and New.

Change between the two styles in the Adv. Config 1 menu.

CLASSIC STYLE SELECT GAS

- The classic Select Gas style is as described on the previous page.
- One gas is shown at a time.
- Press MENU to step through gases, and SELECT to select the shown gas.
- Gases are sorted from highest O2% to lowest O2%.
- Stepping past the last gas will exit the menu without changing the active gas.
- Upon entering the Select Gas menu, the first gas shown is always the highest O2% gas.

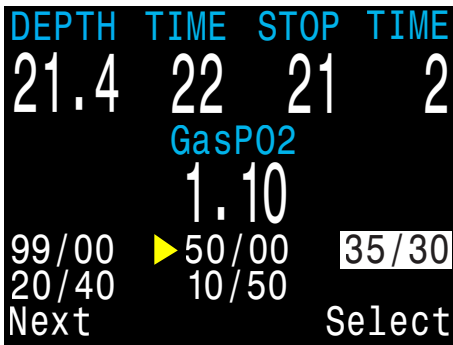

New Style Select Gas

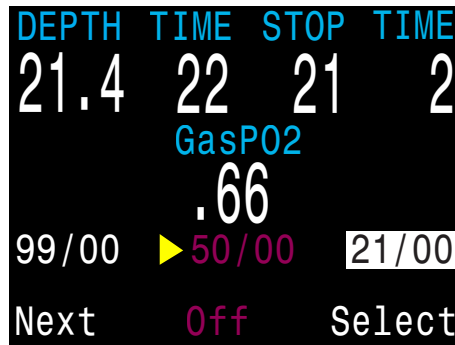

Off Gases are Magenta

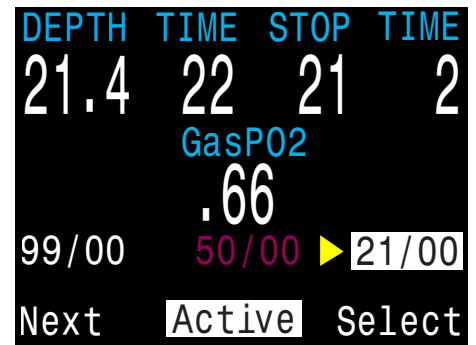

Active Gas is White

NEW STYLE SELECT GAS

The new style makes visualizing the gas list easier. It also reduces button presses for deco gas switches.

- Shows all gases on the screen at once.
- Press MENU to step through gases, and SELECT to select the pointed to gas.
- A gas must be selected to exit the menu (scrolling past last gas wraps back to first gas).
- The active gas is shown with a white background.
- Turned off gases are shown in **Magenta** (purple).
- Gases are sorted from highest O2% to lowest O2%.
- When diving and there is a deco stop, the first gas pointed to will be the most appropriate gas (highest PPO2 less than 1.61). This reduces button presses in most cases.
- On the surface or when no deco stops are needed, the first gas pointed to will be the active gas.

The New Style Select Gas Menu is demonstrated on a Shearwater Petrel here:



Watch the video:
[New Gas Select Style](#)

```

DEPTH  TIME  SURFACE
  0      2hr45mn
.85    .86    .84
Switch CC -> BO
    
```

```

DEPTH  TIME  SURFACE
  0      2hr45mn
Switch BO -> CC
    
```

```

DEPTH  TIME  SURFACE
  0      2hr45mn
Switch BO -> CC
    
```

```

DEPTH  TIME  SURFACE
  0      2hr45mn
    1.3
Switch CC > OC
    
```

```

DEPTH  TIME  SURFACE
  0      2hr45mn
    GasP02
    1.2
Dive Setup+
    
```

```

DEPTH  TIME  SURFACE
  0      2hr45mn
    GasP02
    1.2
Edit Low SP 0.7
NEXT      EDIT
    
```

```

DEPTH  TIME  SURFACE
  0      2hr45mn
    GasP02
    1.2
Edit Low SP 0.4
Change      Save
    
```

SWITCH TO CC/BO

Depending on the current computer setting, this selection will show as either “Switch CC > BO” or “Switch BO > CC”.

Pressing SELECT will select the displayed mode for decompression calculations. When switching to Bailout while diving, the most appropriate open circuit gas will become the breathing gas for calculations.

At this point, the diver may want to switch to a different gas, but since the diver may have other things to deal with, the computer will make a “best guess” of which gas the diver would choose.

On computers with external oxygen sensor monitoring, there is also an option to set the computer to calculate decompression predictions using semi-closed circuit. This is enabled in the System Setup menu.

You can also switch to from CC to BO on a fixed PPO2 model. In that case, the computer will use the user entered high and low setpoints.

DIVE SETUP

The Dive Setup menus are available both on the surface and when diving.

The values in Dive Setup can also be accessed in the Systems Setup menu, but the System Setup menu is not available when diving.

Pressing SELECT will enter the Dive Setup sub-menu.

Low Setpoint CC/BO ONLY

This item allows you to set the low setpoint value. It will display the currently selected value. Values from 0.4 to 1.5 are allowed. A press of MENU will increment the setpoint.

Press the SELECT button when “Edit Low SP” is displayed and the edit display will be shown. It is set at the lowest valid value for setpoint, 0.4.

```

DEPTH  TIME  SURFACE
  0      2hr45mn
      GasP02
      1.2
Edit High SP 1.3
Next           Edit
    
```

Another press of MENU will increment it again.

```

DEPTH  TIME  SURFACE
  0      2hr45mn
      GasP02
      1.2
Edit Low SP 0.5
Change      Save
    
```

If SELECT is pushed, the currently displayed setpoint will be selected, and the display will return to the “Edit Low SP” menu item.

If the highest allowable value, 1.5, has been passed, the value will return to 0.4.

```

DEPTH  TIME  SURFACE
  0      2hr45mn
      GasP02
      1.2
Edit Low SP 1.5
Next           Edit
    
```

High Setpoint CC/BO ONLY

The high setpoint function works exactly like the low setpoint function.

Define Gas

The function allows you to set up 5 gases in Closed Circuit and 5 gases in Open Circuit. You must be in Open Circuit to edit open circuit gases, and you must be in Closed Circuit to edit closed circuit diluents. For each gas, you can select the percentage of oxygen and helium in the gas. The remainder is assumed to be nitrogen.

```
DEPTH TIME STOP TIME
  0
      GasP02
      1.2
Define Gas
Next          Define
```

Pushing SELECT when “Define Gas” is displayed presents the function to define gas number 1.

```
DEPTH TIME STOP TIME
  0
      GasP02
      1.2
  1 OC On 99/00
Next Gas          Edit
```

Pushing the MENU button will display the next gas.

```
DEPTH TIME STOP TIME
  0
      GasP02
      1.2
  2 OC On 50/00
Next Gas          Edit
```

Pushing SELECT will allow you to edit the current gas. The gas contents are edited one digit at a time. The underline will show you the digit being edited.

```
DEPTH TIME STOP TIME
  0
      GasP02
      1.2
  2 OC On 50/00
Change          Next
```

Each push of the MENU button will increment the digit being edited. When the digit reaches 9, it will roll over to 0.

```
DEPTH TIME STOP TIME
  0
      GasP02
      1.2
  2 OC On 50/00
Change          Next
```

```
DEPTH TIME STOP TIME
0
GasP02
1.2
2 0C 0n 50/00
Change Next
```

Pushing SELECT will lock in the current digit, and move on to the next digit.

```
DEPTH TIME STOP TIME
0
GasP02
1.2
2 0C 0n 50/00
Change Save
```

Pushing SELECT on the last digit will finish editing that gas, and bring you back to the gas number.

Any gases that have both oxygen and helium set to 00 will not be displayed in the “Select Gas” function.

```
DEPTH TIME STOP TIME
0
GasP02
1.2
A3 0C 0n 14/55
Next Gas Edit
```

Pushing MENU will continue to increment the gas number.

```
DEPTH TIME STOP TIME
0
GasP02
1.2
2 0C 0n 50/00
Change Save
```

Note: The “A” denotes the active gas. You cannot delete the active gas. If you try, it will generate an error. You can edit it, but cannot set both the O2 and HE to 00.

The computer will display all 5 gas entries available to allow you to enter new gases.

```
DEPTH TIME STOP TIME
0
GasP02
1.2
5 0C 0n 00/00
Done Edit
```

Pressing MENU one more time when the fifth gas is displayed will return you to the “Define Gas” menu item.



WARNING

ONLY TURN-ON GASES YOU ARE CARRYING

Only turn on the gases you are actually carrying on the dive. With radio station gases, the computer has a full picture of the OC and CC gases you are carrying and can make informed predictions about decompression times. There is no need to turn gases off and on when you switch from CC to OC, because the computer already knows what the gas sets are. You should have the CC and OC gases you are actually carrying turned on.

If you often use other gases, but not on this dive, you can enter the gas and turn it off. You can turn gases on and off during a dive and you can also add or remove a gas during the dive if needed.

Dive Planner

Introduction

- Calculates decompression profiles for simple dives.
- In closed-circuit (CC) mode, also calculates open-circuit (OC) bail-out (BO).

Setup

Uses the current gases programmed into the NERD 2, as well as the current GF low/high settings. VPM-B dive planning is available on units with the optional VPM-B unlock. Deco profile is computed for the current circuit mode (CC or OC).

On the surface

Enter the dive bottom depth, bottom time, respiratory minute volume (RMV) and PPO2 (closed-circuit only).

Note: Residual tissue loading (and CNS%) from recent dives will be used in calculating the profile.

CC	Depth	Time	RMV	P02
	150	030	.25	1.3

Enter Bottom Time
in minutes
Min: 5
Max: 180

Change Next

Dive Plan Setup

During a dive

Computes the decompression profile assuming the ascent will begin immediately. There are no settings to enter. (RMV is last used value)

Limitations

The NERD 2 Dive Planner is intended for simple dives. Multi-level dives are not supported.

The NERD 2 Dive Planner makes the following assumptions:

- Descent rate is 60ft/min (18m/min) and the ascent rate is 33ft/min (10m/min).
- For OC, the gas in use will be the gas with the highest PPO2 less than 1.40 for the bottom gas, and 1.61 for deco gases (the deco gas max PPO2 can be changed in the Adv Config 1 menu).
- For CC, the gas in use will be the gas with the highest PPO2 less than 1.05.
- The planner will use the configured last stop depth.
- For CC, the PPO2 is constant for the entire dive.
- The RMV is the same while diving as during deco. Semi-closed uses a metabolic offset

The Dive Planner does not provide thorough validation of the profile. For example, it does not check for nitrogen narcosis limitations, gas usage limitations, CNS percentage violations, or isobaric counter-diffusion risks due to sudden helium switches. The user is responsible for ensuring a safe profile is followed.

Result screens

The results are given in tables showing:

- ⌚ Stp: Stop Depth In feet (or meters)
- ⌚ Time: Stop Time In minutes
- ⌚ Run: Run Time In minutes
- ⌚ Qty: Gas Quantity in CuFt (or liters). OC and BO only

The first few rows will show the bottom time (bot) and the ascent legs (asc) to ascend to the first stop. Multiple ascent legs may be shown if gas switches are needed.

CC				
Depth	Time	RMV	P02	
150	030	.55	1.3	
Stp	Tme	Run	Gas	
150	bot	30	10/50	
70	asc	32	10/50	
70	1	33	10/50	
60	2	35	10/50	
50	1	36	10/50	
Quit			Next	

BO				
Depth	Time	RMV	P02	
150	030	.55	1.3	
Stp	Tme	Run	Gas	Qty
30	5	43	36/00	6
20	6	49	99/00	6
10	11	60	99/00	8
Quit			Next	

Example Results Table for Closed-Circuit and Bailout.

If more than 5 stops are needed, the results will be split onto several screens. Use the right button to step through the screens.

For OC or BO profiles, a total gas consumption report is given.

BO				
Depth	Time	RMV	P02	
150	030	.55	1.3	
Gas Usage. In CuFt				
99/00:		14		
36/00:		14		
21/25:		7		
12/50:		0		
Quit			Next	

Gas Usage Report

The final result screen shows the total dive time, the time spent on deco and final CNS%.

```
CC Depth Time RMV P02
   150  030 .55 1.3
CC Summary
Run:   61 minutes
Deco:  31 minutes
CNS:   34%
-----
Quit           Plan B0
```

Results Summary Screen

If no decompression is required, no table will be shown. Instead, the total No-Decompression-Limit (NDL) time in minutes, at the given bottom depth will be reported. Also, the gas quantity required to surface (bailout in CC) will be reported.

```
CC Depth Time RMV P02
   150  030 .55 1.3
No Deco Stops.
Total NDL at 80ft
is 47 minutes
Bailout gas quantity
is 4 CuFt.
-----
Quit           Done
```

No Decompression Results Screen

Conservatism

The conservatism settings (GF High and GF Low) can be edited in the Dive Setup menu. While diving, only the GF High value can be edited. This allows changing the surfacing conservatism during a dive. For example, if you worked much harder on the bottom segment than expected, you may wish to add conservatism by reducing the GF High setting

```
DEPTH TIME STOP TIME
  0
.85 .7 .84
Conserv 30/70
Next           Edit
```

NDL Display

The NDL Display option allows you to display five different values during the dive. The display can be changed during the dive to provide different information. The value selected here replaces the NDL on the main screen once decompression stops are required.

- 1 NDL
- 2 CEIL
- 3 Buhlmann (GF99)
- 4 @+5
- 5 Δ+5

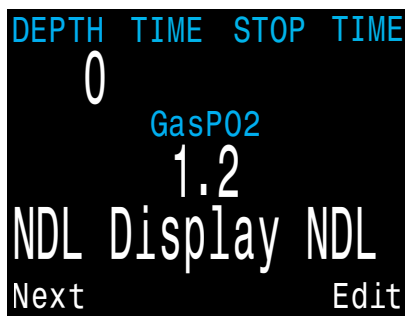

- 1 Pushing SELECT will make the NDL display editable. The first choice available will be **NDL**. If you select NDL, the NDL will always be displayed during the dive whether or not you have a decompression ceiling.

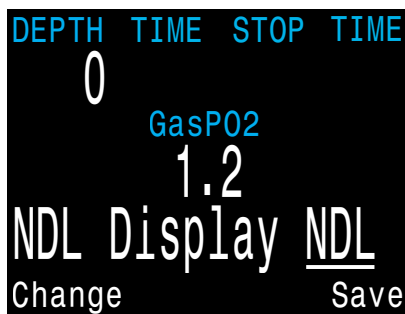

- 2 The next selection is **CEIL**. With this setting, as long as the NDL time is 0 (you have a decompression ceiling), the raw ceiling will be displayed instead of the NDL. This is the equivalent of the 'Man on a rope'. It will show your ceiling without it being rounded up to the next even 10 foot or 3 meter stop. Please note that there is very limited information on the effects of following a continuous ceiling instead of stopping at stops and only moving up to the next stop when the stop has cleared.

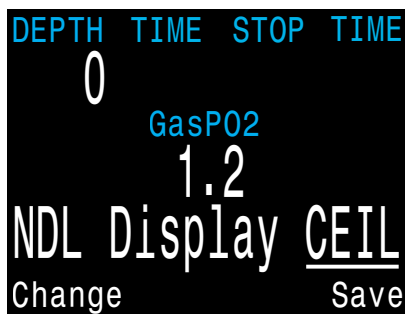

It is Shearwater's opinion that all stops should be honored. It seems intuitive that if you have bubbles, and you stop, you give the bubbles an opportunity to be reabsorbed. If you continuously ascend, the ambient pressure is continuously reduced which prevents bubbles from shrinking. Because of this belief, the computer will give one **MISSED DECO STOP** message during the dive and one after the dive, and will flash the stop depth and time in **red** as long as you are above the stop depth. It will use the increased gradient though, and your calculated off-gassing will be faster than staying at the stops.

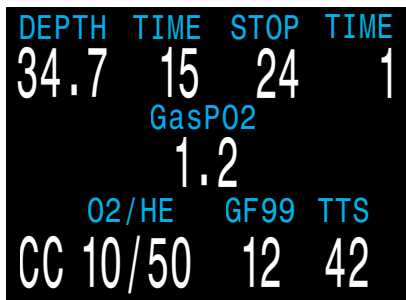
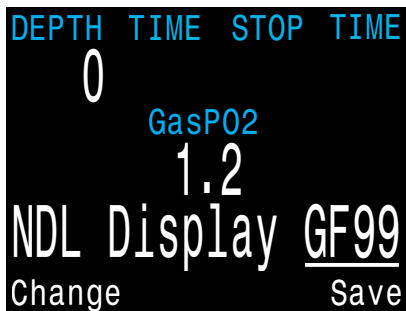

- 3 The next option is to display the actual supersaturation gradient for a pure Bühlmann (99/99) profile.

The selection is **GF99**. With this setting, as long as the NDL time is 0 (you have a decompression ceiling), the gradient will be displayed instead of the NDL.

The number shown is the percentage of supersaturation. The number is calculated by reference to the Ambient Pressure Line and the M-Value line. It can be thought of as the current GF, but it is different in a couple of ways. First, the current GF generates stops rounded to the nearest 10 feet or 3 meters. So a gradient of 40 may reflect a ceiling of 15 feet, but the computer will show a rounded-up 20 foot stop.

This number can be used in several ways. First, it can be used to calculate an aggressive ascent that still has some justification in decompression science. For example, if a diver were to lose a significant portion of their gas and needed to get shallow fast, they could ascend until they reached a gradient of 90, then stop until it dropped to 80, then ascend to 90 again, etc. That would produce a Bühlmann-like profile with very little conservatism. In an emergency, that may be an acceptable risk.

Another use might be to do a slower ascent on a dive to sightsee, but to stay in the decompression zone by keeping the gradient above 0.

Another use would be to observe the rapidly increasing gradient in the last 10 feet to the surface and slow that ascent.

All of this is based on gradient theory that may be completely false. There is significant disagreement in the decompression research community about the nature and practice of decompression. Any techniques described here should be considered experimental, but the concepts may be useful to the advanced diver.

Pressure Graph: Gradient Factors

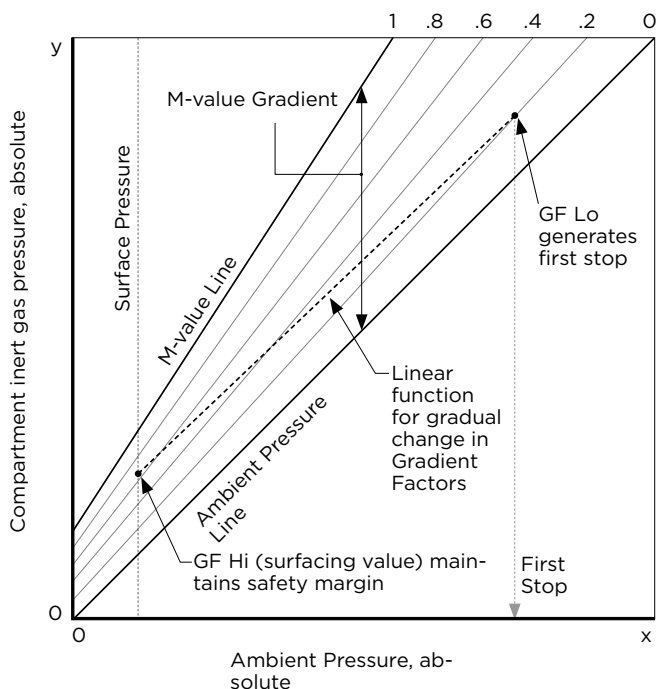

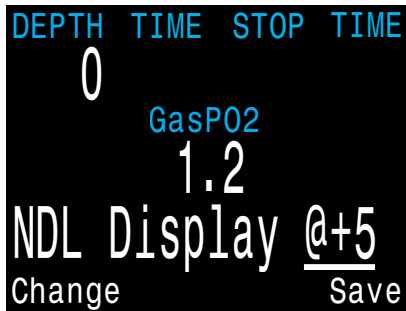

- 4 The next selection is **@+5**. This feature was inspired by Dan Wible's CCR2000 computer (Thanks Dan!). It is the time-to-surface (TTS) if you were to stay at the current depth for five more minutes. This can be used as a measure of how much you are on-gassing or off-gassing.

For example, on a dive on a wreck, you go to the bottom until you accumulate the desired decompression and TTS. After ascending to the second deck, you notice that the @+5 and TTS are the same. That means that you can spend 5 minutes exploring this deck without incurring more decompression.

Once you get to the top deck, the current has picked up. The line runs from the top of the deck to the surface which is a distance of 30 feet/10 m. You see that your @+5 is 11 minutes and your TTS is 15 minutes. That means that you can stay down out of the current for 5 minutes and burn off about 4 minutes of deco. You may decide to accept the 80% decompression efficiency and stay out of the current.

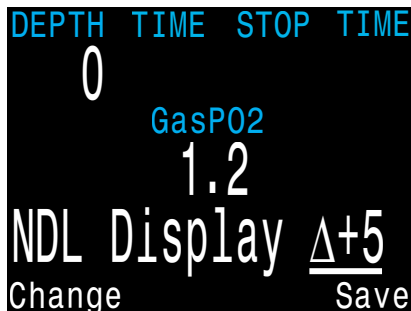

- 5 When your TTS is 10 minutes, you see that your @+5 is 9 minutes. Since the decompression is not very efficient now, you go up the line and spend the last 10 minutes in the current.

The last selection option is **Δ+5**. This feature is an expansion on **@+5** where the value displayed is the **difference between @+5 and TTS**. This value lets you know at a glance if you are on-gassing or off-gassing without having to compare TTS and **@+5** directly.

If you are on-gassing, **Δ+5** will show a positive time in minutes in **red**. If you are off-gassing, **Δ+5** will show a negative time in minutes in **green**. This will give you a quick real-time indication of how your decompression schedule is changing.

EXTERNAL PPO2 MONITORING FC DCM

The next menu item is used to turn external PPO2 monitoring on and off. By default, external monitoring is turned off and reads “Int.” for Internal fixed setpoint mode. This setting can be changed to “Ext.” to enable external PPO2 monitoring from oxygen sensors.

Now the PPO2 of the three sensors is displayed. A valid calibration must have been previously performed (see the Calibration section).

This system is plugged into three sensors and using the PPO2 input from the sensors as the system average PPO2 used for decompression calculations and CNS tracking.

VOTING

A voting algorithm is used to decide which of the three sensors are likely to be correct. If a sensor matches either of the other two sensors within ±20%, it passes voting. The system average PPO2 is the average of all sensors that have passed voting.

For example, here sensor 3 has failed voting. The PPO2 is displayed in yellow to show that it has failed voting. The system average PPO2 is the average PPO2 of sensor 1 and 2.

If all sensors fail voting, then the display will alternate VOTING FAILED with the PPO2 measurements (which will all be yellow to indicate that voting has failed). When voting has failed, the lowest PPO2 reading will be used for deco calculations (i.e. the most conservative value).

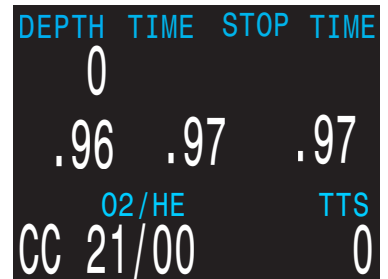
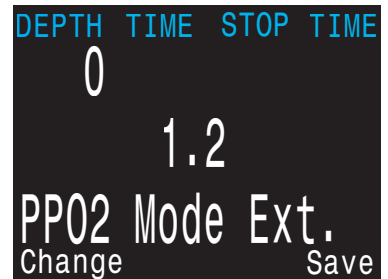
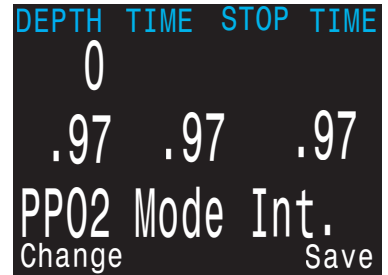

Switching to Open Circuit bailout (BO) with External PPO2 Monitoring

FC DCC DCM

If you bailout to BO mode, the external PPO2 will continue to display on the main screen. However, the system PPO2 used for deco calculations will change to OC mode (i.e. PPO2 is the fraction of O2 multiplied by the current depth's pressure).

The external PPO2 continues to display because the diver may need to return to the loop, and will need to know the PPO2 status of the loop, even though the sensor input is not being used as the system PPO2.

The solenoid control system will also continue to maintain the loop PPO2 independent of if you are in CC or BO mode. When switching to BO mode, the system automatically switches to the low setpoint.

```
DEPTH TIME STOP TIME
30.4 42 30 2
.48 .97 1.26
Switch CC -> BO
```

```
DEPTH TIME STOP TIME
30.4 42 30 2
.48 .97 1.26
O2/HE GF99 TTS
BO 21/00 58% 80
```

```
DEPTH TIME STOP TIME
30.4 42 30 2
.48 .97 1.26
CNS PPO2
45 0.84
```

BRIGHTNESS



The display brightness has four fixed brightness settings.

The fixed options are:

- 🔦 **Cave:** Longest battery life.
- 🔦 **Low:** Second longest battery life.
- 🔦 **Med:** Best mix of battery life and readability.
- 🔦 **High:** Easiest readability, especially in bright sunlight.

DIVE LOG MENU



Display Log

At the “Display Log” prompt, press SELECT to view the most recent dive.

The profile of the dive is plotted in blue, with decompression stops plotted in red. The following information is displayed:



- Maximum and Average depth
- Dive number
- Date (dd/mon/yyyy)
- Start - Time of day dive started
- End - Time of day dive ended
- Length of dive in minutes

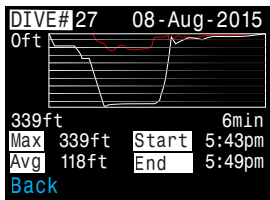

Press MENU to see the next dive, or SELECT to quit viewing logs. Press Back to see the list of dive logs, and next to select the next dive and View.

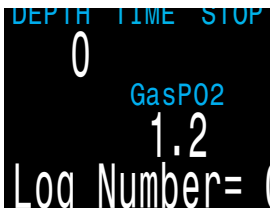

Next Log Number

The dive log number can be edited. This is useful if you want the NERD 2 log numbers to match your lifetime dive count.

At the “Next Log Number” prompt, press SELECT to begin editing. While editing, use MENU to change the value of the currently underlined digit, and SELECT to move to the next digit.

This number will be applied to the next dive.

Restore Mode

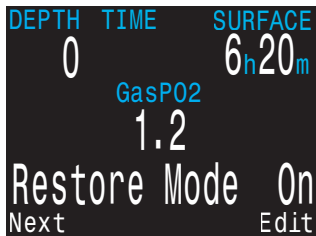

Restore mode can be toggled on and off. When toggled on, it shows deleted logs, greyed out in the "Display Log" sub-menu. These dives can be restored to the Dive Log.

The Delete All Logs option is also changed to Restore All Logs when Restore mode is enabled.

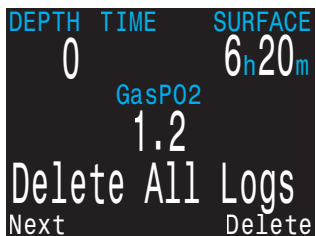

Delete All Logs

Deletes All of the Logs.

Deleted Logs can be restored by toggling Restore Mode to on.

See the Dive Log functionality demonstrated on a Shearwater Petrel here:



Watch the video:

[Dive Log](#)

SYSTEM SETUP

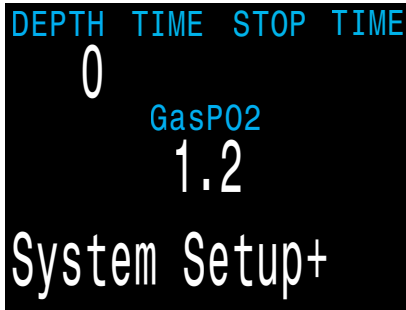

System Setup contains configuration settings together in a convenient format for updating the configuration before a dive.

System Setup cannot be accessed during a dive.

However, many of the settings are also available during the dive in a single line interface. Although all of the settings available in Dive Setup are available in System Setup, not all settings in System Setup can be edited in Dive Setup.

The MENU and SELECT buttons are context sensitive to each sub menu and individual setting.

Example Menu		Example Menu	
▶ Example	0.00	▶ Example	<u>0.00</u>
Example	0.00	Example	0.00
Example	0.00	Example	0.00
Example	0.00	Example	0.00
Example	0.00	Example	0.00
Next	Edit	Change	Next

When cycling through the sub-menus, MENU will carry the user to the next sub-menu, while SELECT will allow the user to edit the options in this submenu.

Once the user has pressed SELECT to edit a submenu, MENU will cycle the user through the different submenu listings, while SELECT will let the user edit those listings.

Once the user has pressed SELECT to edit a submenu listing MENU will be used to change the context sensitive variable, while the SELECT button will be used to move to the next field. Once the user has pressed SELECT through all the fields, the new user preferences will be saved.

MODE SETUP

The first submenu of System Setup is Mode Setup.

Mode Setup	
Mode	CC/BO
Salinity	Fresh
PPO2 Mode	Int.
Low SP	0.7
High SP	1.3
Next	Edit

Mode

Mode sets which breathing circuit configurations are available:

- 🔗 CC/BO
- 🔗 SC/BO FC
- 🔗 OC Tec
- 🔗 OC Rec
- 🔗 Gauge (e.g. bottom timer mode)
- 🔗 PPO2

When changing to or from Gauge / PPO2 mode, the decompression tissues are cleared. This is because when in Gauge mode the NERD 2 does not know what gas you are breathing, and therefore cannot track inert gas loading.

Salinity

Water type (salinity) affects how the measured pressure is converted to depth. Settings:

- 🔗 Fresh
- 🔗 EN13319
- 🔗 Salt

Freshwater and Saltwater differ by about 3%. Saltwater, being denser, will display a shallower depth for the same measured pressure versus the Fresh setting.

The EN13319 value is between Fresh and Salt. It is from the European CE standard for dive computers, and is the NERD 2's default value.

▶ Mode Setup	
Mode	CC/B0
Salinity	Salt
PPO2 Mode	Int.
Low SP	0.7
High SP	1.3
Next	Edit

PPO2 Mode

PPO2 mode is only set when CC is enabled.

On the SA model this value is always Int. (internal fixed PPO2).

On the DiveCAN Controller model this value is always Ext. (externally monitored PPO2).

On the Fischer or DiveCAN Monitor models this value can be set to either Int. or Ext.

Low and High Setpoints

The Low and High PPO2 Setpoints are only available when CC is enabled.

Each setpoint can be set from 0.4 to 1.5.

The setpoints can also be edited, even during a dive, in the Dive Setup menu.

▶ Deco Setup	
Deco Model	GF
Conserv (GF)	30/70
Last Stop	6m
NDL Display	CEIL
Next	Edit

DECO SETUP

Deco Model

May just show Bühlmann ZHL-16 with gradient factors model, or it may allow you to switch between GF and various types of VPM-B. The choices will be available if you have unlocked VPM-B.

Conservatism

Can be adjusted in either the GF or VPM model. For a more detailed explanation of their meaning for the GF algorithm, please refer to Erik Baker’s excellent articles: **Clearing Up The Confusion About “Deep Stops”** and **Understanding M-values**. The articles are readily available on the web. VPM-B has conservatism settings from 0 to +5, with higher numbers being more conservative.

Last Stop

Allows you to choose where to do your last stop. The choices are 10ft/3m and 20ft/6m. Note that this setting does not affect decompression. It only makes the TTS prediction more accurate.

NDL Display

These options were previously covered in the Dive Setup section.

OC Gases

The next submenu is OC Gases. This menu allows the user to edit the open circuit gases. The options contained here are the same as those in the “Define Gases” subsection of the “Dive Setup” section contained earlier in this manual. This menu page conveniently displays all five gases simultaneously.

For a description of how to appropriately set each gas, please see the earlier Define Gas section

CC Gases

The next submenu is CC Gases. This menu allows the user to edit the closed circuit diluent gases. The options contained here are the same as those in the “Define Gases” subsection of the “Dive Setup” section contained earlier in this manual. This menu page conveniently displays all five gases simultaneously.

For a description of how to appropriately set each gas, please see the earlier Define Gas section.

▶ OC Gases			
1	OC	On	21/00
2	OC	Off	00/00
3	OC	Off	00/00
4	OC	Off	00/00
5	OC	Off	00/00
Next	Edit		

▶ CC Gases			
A1	CC	On	21/00
2	CC	Off	00/00
3	CC	Off	00/00
4	CC	Off	00/00
5	CC	Off	00/00
Next	Edit		

O2 Setup FC DCC DCM

This menu page is only available in Closed-Circuit (CC) or Semi-Closed (SC) mode when PPO2 mode is set to external (see Dive Setup page).

Cal. FO2

This setting allows you to set the fraction of oxygen (FO2) of the calibration gas.

In CC mode, the calibration gas FO2 can be set from 0.70 to 1.00. The default value of 0.98 is for pure oxygen, but assumes about 2% water vapor due to the diver's breathing on the loop during the flushing process.

In SC mode, the calibration gas FO2 can be set from 0.20 to 1.00. This is because semi-closed divers do not always have oxygen available.

Note: When in SC mode the user cannot utilize internal PPO2 monitoring.

Sensor Disp

Sets the sensor display mode on the center row of the main screen.

In CC mode, the available settings are:

Large: the PPO2 text is the normal large font.

Giant: the PPO2 text is larger.

In SC mode, the available settings are:

PPO2: the PPO2 is shown.

FiO2: the Fraction of inspired O2 (FiO2) is shown.

Both: PPO2 shown is large font, FiO2 below in small font.

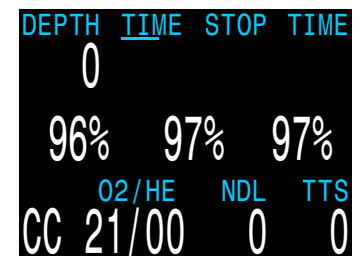
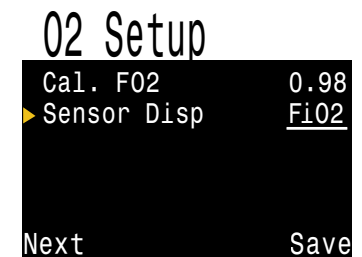
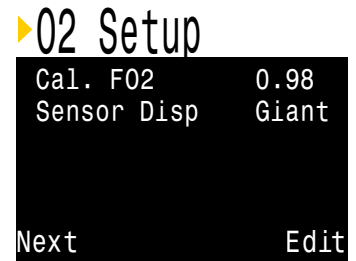

In SC Mode, the center row can show FiO2 instead of PPO2

```

▶Auto SP Switch
Up:    0.7>1.3  Auto
Up Depth    070ft

Down:    1.3>0.7  Auto
Down Depth  040ft
Next      Edit
    
```

Auto SP (Setpoint) Switch

This menu page is only available in CC mode when PPO2 mode is set to internal (see Dive Setup page).

Auto Setpoint Switch configuration sets up the setpoint switching. It can be set up to auto switch up only, down only, both, or neither.

First, you set whether the “Up” switch occurs automatically or manually. If “Up” is set to “Auto”, then you can set the depth at which the auto switch occurs.

The menu options are the same for the down setpoint switch.

Example:

Up: 0.7 > 1.3 = Auto, Up Depth = 70 ft.

Down: 1.3 > 0.7 = Auto, Down Depth = 41ft

```

Auto SP Switch
Up:    0.7>1.3  Auto
▶Up Depth    070ft

Down:    1.3>0.7  Auto
Down Depth  041ft
Change    Next
    
```

The dives starts at the 0.7 setpoint. As you descend past 70ft, the setpoint switches “up” to 1.3.

You finish your bottom time, then begin ascending. When you ascend above 41ft, it switches “down” to 0.7.

```

Auto SP Switch
Up:    0.7>1.3  Auto
Up Depth    070ft

▶Down:    1.3>0.7  Manual
Change    Save
    
```

When a switch is set to “Auto”, you can always manually override the setting at any time during the dive.

The automatic switches only occur when crossing the specified depth. Say for example, the switch up depth is set to 50ft. You start the dive on the low setpoint, then as you descend past 50ft, the setpoint automatically switches up to high. If at say 80ft you then manually switch back to the low setpoint, the setpoint will remain low. If you ascend shallower than 50ft then re-descend deeper than 50ft again, the automatic setpoint switch will occur again. The Perdix enforces a 20ft (6m) gap between switch up and switch down depths to prevent rapid automatic switching between setpoints for small depth changes. The values 0.7 and 1.3 are shown as examples only. Other values for the low and high setpoint can be adjusted in the Dive Setup menu.

Display Setup

Display Setup	
▶Units	Feet
Brightness	Auto
Altitude	SeaLvl
Flip Screen	
Next	Edit

Depth and temperature units can be set independently.

Depth Units

Two options are available:

Feet: Imperial units

Meters: Metric units

Temp Units

Two options are available:

°F: Imperial units

°C: Metric units

Display Setup	
Units	Feet
▶ <u>B</u> rightness	<u>Med</u>
Altitude	SeaLvl
Flip Screen	
Change	Save

Display Setup	
Units	Feet
▶Brightness	<u>Auto</u>
Altitude	SeaLvl
Flip Screen	
Change	Save

Brightness

Screen brightness can be set to one of four fixed levels.

Options:

Cave: Made specifically for cave conditions. Longest battery life.

Low: Second longest battery life.

Med: Best mix of battery life and readability.

High: Easiest readability, especially in bright sunlight.

Altitude

The altitude setting when set to 'Auto' will compensate for pressure changes when diving at altitude. If all your diving is at sea level, then setting this to 'SeaLvl' will assume that surface pressure is always 1013 mBar (1 atmosphere).

Display Setup		Display Setup	
Units	Feet	Units	Feet
Brightness	Auto	Brightness	Auto
▶Altitude	<u>Auto</u>	▶Altitude	<u>SeaLvl</u>
Flip Screen		Flip Screen	
Change	Save	Change	Save

If the NERD 2 measures the surface pressure to be less than 965 mbar, then the Altitude setting will be forced to "Auto" and cannot be changed.



DETERMINATION OF SURFACE PRESSURE

Accurate depth measurements and decompression calculations require knowing the ambient atmospheric pressure at the surface. Regardless of turn on method, the surface pressure is determined the same way. While in the off state the surface pressure is measured and saved every 15 seconds. A 10 minute history of these pressure samples is kept. Immediately after turn-on this history is examined and the minimum pressure is used as the surface pressure. The surface pressure is then remembered, and not updated again until the next turn-on.

Flip Screen

This function displays the contents of the screen upside down.

The Flip Screen option is useful if helmet or mask mounting the NERD 2

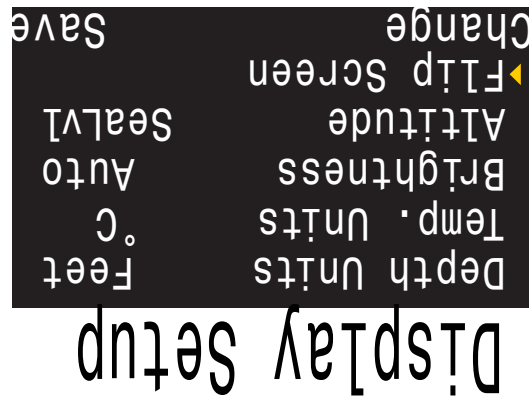

COMPASS SETUP

Compass	
▶Compass View	90°
Calibrate	
True North	+0°
Next	Edit

Compass View

The Compass View setting can be set to the following:

- 🔴 Off: The compass is disabled.
- 🔵 60°, 90°, or 120°: Sets the range of the compass dial that is visible on the main screen. The actual amount of arc that there is room for on the screen is 60°, so this may feel the most natural. The 90° and 120° settings allow a wider range to be seen at once. The default is 90°.

Compass	
Compass View	90°
Calibrate	
▶True North	+0°
Next	Edit

True North

In most places, a compass does not point towards True North, but rather to Magnetic North. The difference in angle between these two directions is called the magnetic declination (also called magnetic variation), and varies around the world. The declination in your location can be found on maps or by searching online.

This setting can be set from -99° to +99°.

If you only need to match an uncompensated compass, or your navigation is all based on relative directions, then this setting is not necessary and can be left at 0°.

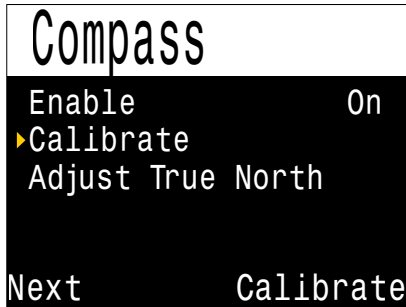

Calibrate

Calibration of the compass may be needed if the accuracy drifts over time or if a permanent magnet or ferromagnetic metal (e.g. iron or nickel) object is mounted very close to the NERD 2. To be calibrated out, such an object must be mounted with the NERD 2 so that it moves along with the NERD 2.

Compare the NERD 2 with a known good compass or fixed references to determine if calibration is needed. If comparing against fixed references, remember to consider the local deviation between Magnetic North and True North (declination).

Calibration is typically not needed when travelling to different locations. The adjustment needed then is the True North (declination).

When calibrating, rotate the NERD 2 smoothly through as many 3D twists and turns as possible in 15 seconds. Keep metal and magnetic objects away during calibration. The calibration can also be reset back to the factory values. After calibration, it is recommended to compare the compass accuracy with a known good compass or fixed references



TIPS FOR A GOOD COMPASS CALIBRATION

- Stay away from metal objects. For example, wrist watches, metal desks, boat decks, desktop computers, etc. can all interfere with the Earth's magnetic field.
- Rotate to as many 3D positions as possible. Upside down, sideways, on edge, etc.
- Compare with another compass (not a smartphone as those are terrible) to check your calibration.

SYSTEM SETUP

Date

The first 'System Setup' changeable option is 'Date,' which allows the user to set the current date.

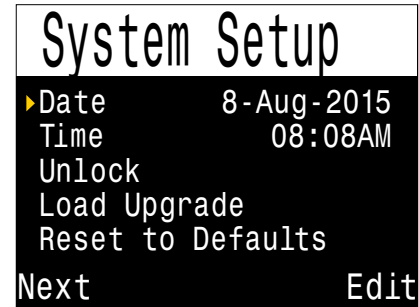

Time

The next 'System Setup' changeable option is 'Time', which allows the user to set the current time. The format can be set to AM, PM or 24 hour time

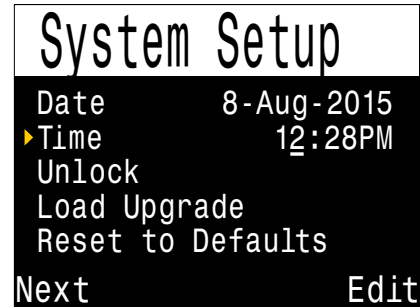

Unlock Code

The next 'System Setup' changeable option is 'Unlock' which allows the user the VPM-B Unlock in a code in order to add a 2nd decompression algorithm

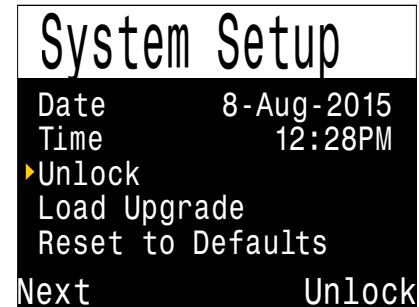

Reset to Defaults

The final 'System Setup' option is 'Reset to Defaults'. This will reset all user changed options to factory settings and clear the tissues on the NERD 2. 'Reset to Defaults' cannot be reversed.

Note: This will not delete dive logs, or reset dive log numbers.

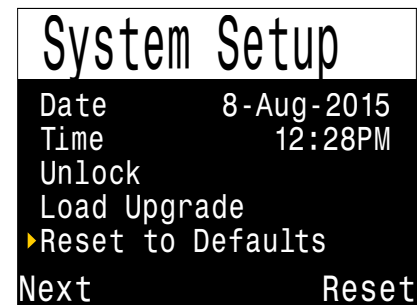

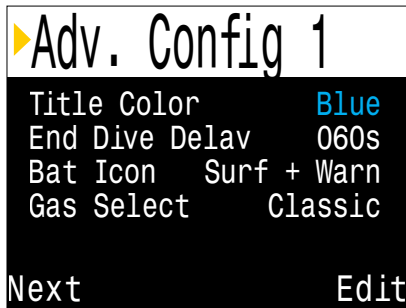
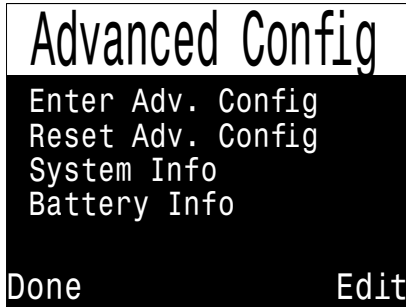

ADVANCED CONFIGURATION 1

Advanced configuration contains items that will be used infrequently and can be ignored by most users. They provide more detailed configurations.

The first screen allows you to enter the advanced configuration area, or to set the advanced configurations settings to their default.

Title Colour

The title colors can be changed for added contrast or visual appeal. Default is Cyan, with gray, white, green, red, and blue also available.

Main Colour

Main colours can also be changed for added contrast. Default is white but can be changed to green or red.

End Dive Delay

Sets the time in seconds to wait after surfacing before ending the current dive.

This value can be set from 20 seconds to 600 seconds (10 minutes). Default is 60s.

This value can be set to a longer time if you want brief surface intervals connected together into one dive. Some instructors use a longer end dive delay when teaching courses. Alternatively, a shorter time can be used to exit dive mode more quickly upon surfacing.

Battery Icon

The behavior of the battery icon can be changed here. Options are:

Surf+Warn: The battery icon always displays when on the surface. During dive it displays only if there is a low battery warning.

Always: The battery icon always displays.

Warn Only: The battery icon only appears when there is a low battery warning (this is how the Predator operates).

Gas Select

The style of Select Gas menu. Either Classic or New. Classic style shows one gas at a time in the large font. New style shows all gases at once, but in the small font.

ADVANCED CONFIGURATION 2

This section allows changing of PPO2 limits.



WARNING

Do not change these values unless you understand the effect.

All values are in absolute atmospheres [ata] of pressure (1 ata = 1.013 Bar)

► Adv. Config 2		
OC Min.	PP02	0.19
OC Max.	PP02	1.65
OC Deco	PP02	1.61
CC Min.	PP02	0.40
CC Max.	PP02	1.60
Done		Edit

OC Min. PPO2

PPO2 displays in flashing red when less than this value. (Default 0.19)

OC Max. PPO2

PPO2 displays in flashing red when greater than this value. (Default 1.65)

OC Deco. PPO2

The decompression predictions (TTS and NDL) will assume that the gas in use at a given depth is the gas with the highest PPO2 that is less than or equal to this value. Also, the suggested gas switches (when the current gas is displayed in yellow) are determined by this value. If you change this value, please understand its effect. For example, if lowered to 1.50, then oxygen (99/00) will not be assumed at 20ft/6m. (Default 1.61)

CC Min. PPO2

PPO2 displays in flashing red when less than this value. (Default 0.40)

CC Max. PPO2

PPO2 displays in flashing red when greater than this value. (Default 1.60)

Note: In both OC and CC mode, a “Low PPO2” or “High PPO2” alert is displayed when the limits are violated for more than 30 seconds.



There is no bottom gas setting! Do not set OC Max less than OC Deco. OC Max applies for the entire dive and is only used to alert high PPO2 warnings.

STARTING BLUETOOTH

Bluetooth communications are used for both Firmware Uploading and Dive Log Downloading.

To start Bluetooth on your dive computer, simply press the left button 4 times, followed by the right button once.



FIRMWARE UPDATE

It is important to keep the firmware on your dive computer up to date. In addition to new features and improvements, firmware updates address important bug fixes.

There are two ways to update the firmware on your NERD 2:

- 1) With Shearwater Desktop
- 2) With Shearwater Cloud Mobile

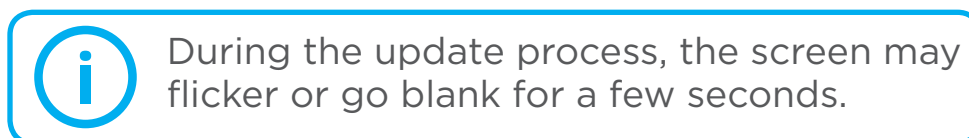

FIRMWARE UPLOAD USING SHEARWATER DESKTOP

Ensure that you have the latest version of Shearwater Desktop. You can get it by [clicking here](#)

In Shearwater Desktop, go to **Dive Computer** ➔ **Update Firmware**

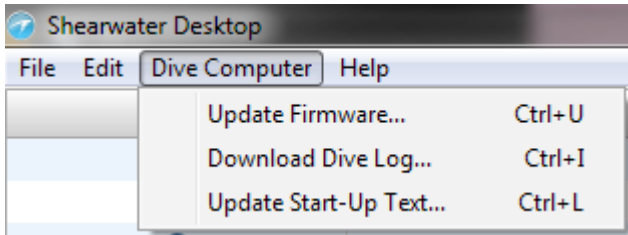

Shearwater Desktop will detect your dive computer once you start Bluetooth and will automatically select the latest available firmware.

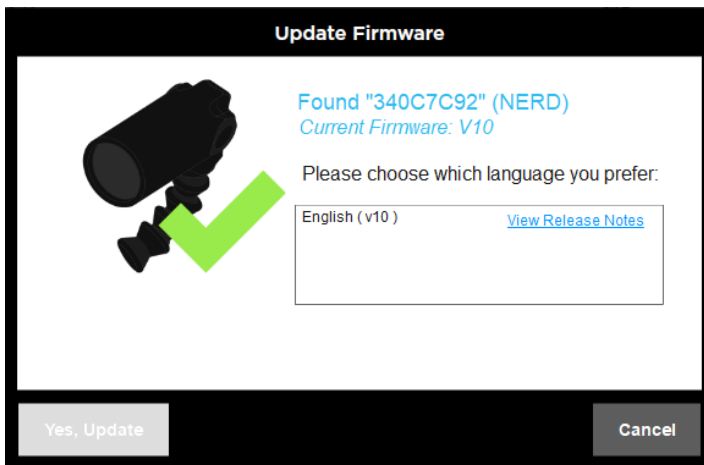

Confirm the update and Shearwater Desktop will send the firmware update to your NERD 2.

The NERD 2 screen will give percentile updates of receiving the firmware, and then the Personal Computer will read “Firmware successfully sent to the computer” on completion.

After receiving the new firmware, the NERD 2 will reset and display a message stating either firmware update success or failure.

FIRMWARE UPLOAD USING SHEARWATER CLOUD MOBILE

Ensure that you have the latest version of Shearwater Cloud Mobile. Download it from [Google Play](#) or the [Apple App Store](#).

- 1) Start Bluetooth on your dive computer
- 2) Go to the connect tab on the Shearwater Mobile App
- 3) Connect your dive computer
- 4) Press the UPDATE FIRMWARE button
- 5) Select your language
- 6) Shearwater cloud mobile will send the new firmware version

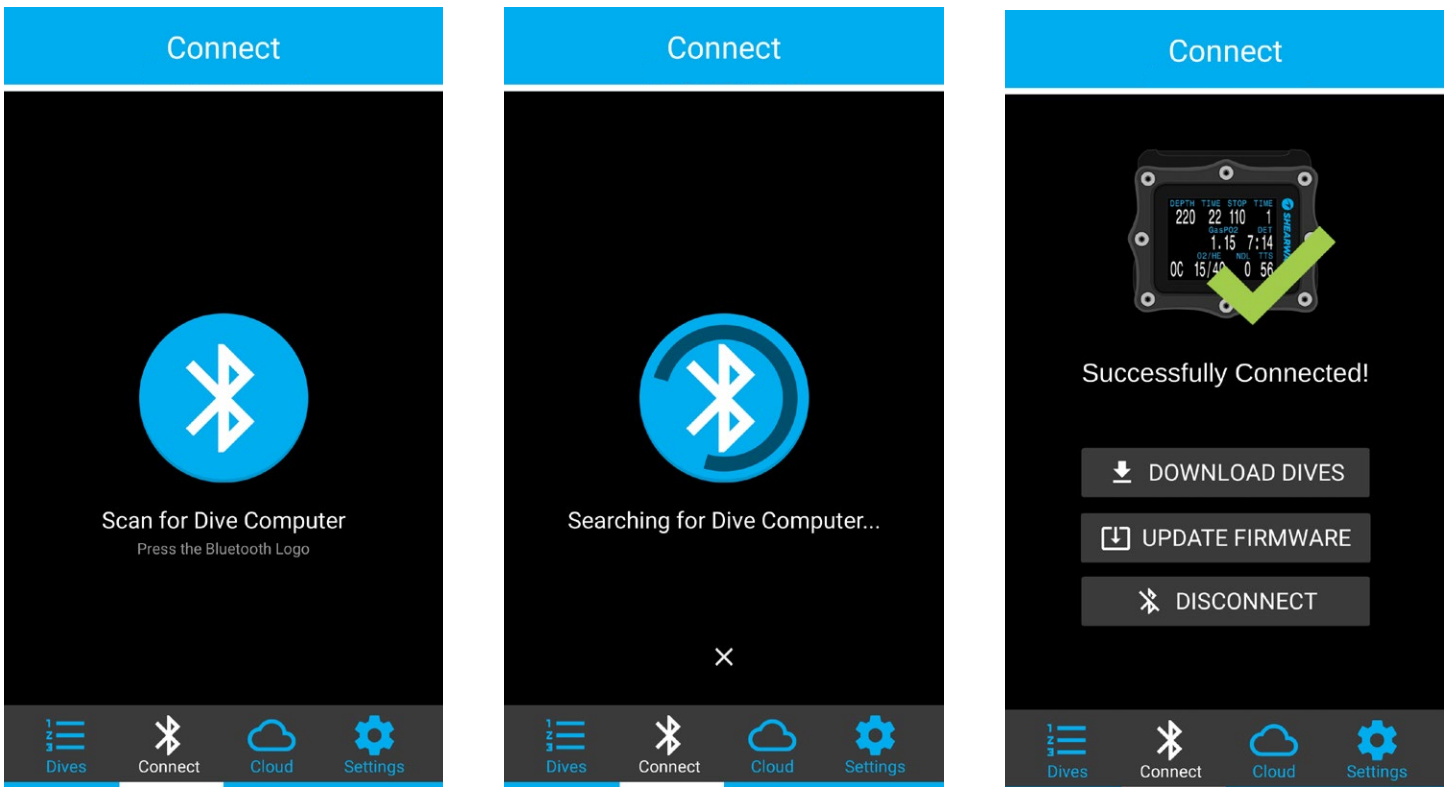

The NERD 2 screen will give percentile updates while receiving the firmware, and the phone will read “Firmware successfully sent to the computer” upon completion.

After receiving the new firmware, the NERD 2 will reset and display a message stating either firmware update success or failure.

DIVE LOG DOWNLOAD

DIVE LOG DOWNLOADING WITH SHEARWATER DESKTOP

In Shearwater Desktop, go to Dive Computer → Download Dive Log

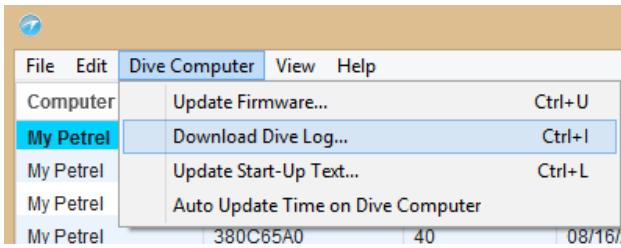

The Download Dive Log window should pop up.

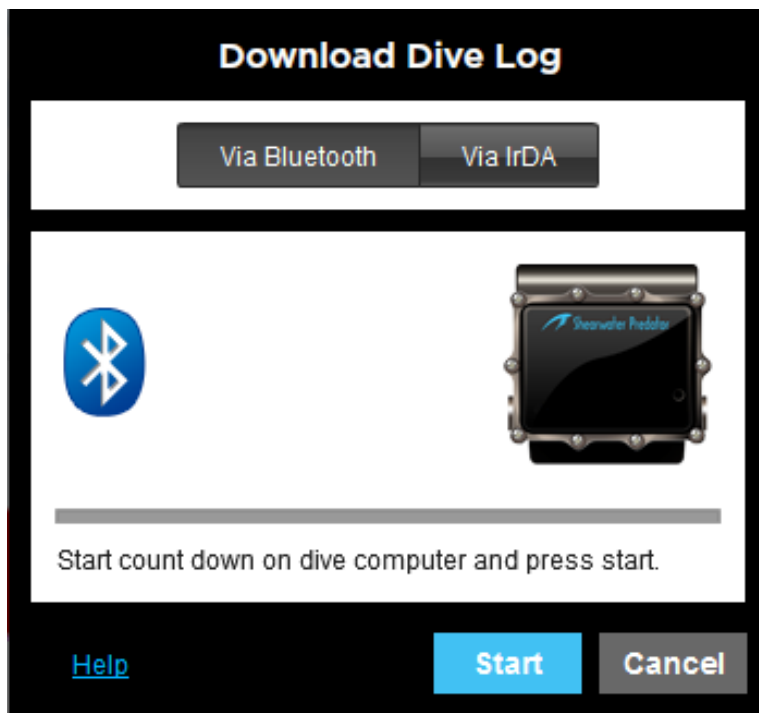

Start Bluetooth on your NERD 2

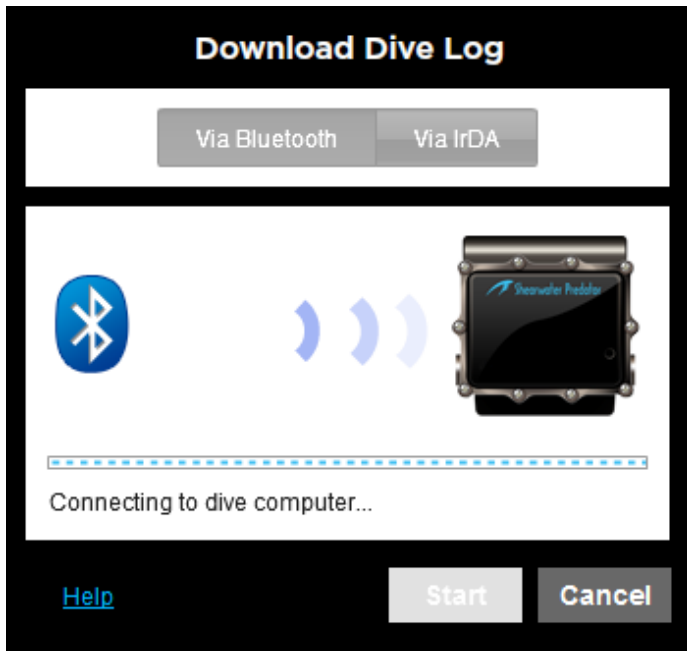

Now go back to Shearwater Desktop. Click start from the open “Download Dive Log” box. The PC will then connect to the NERD 2.

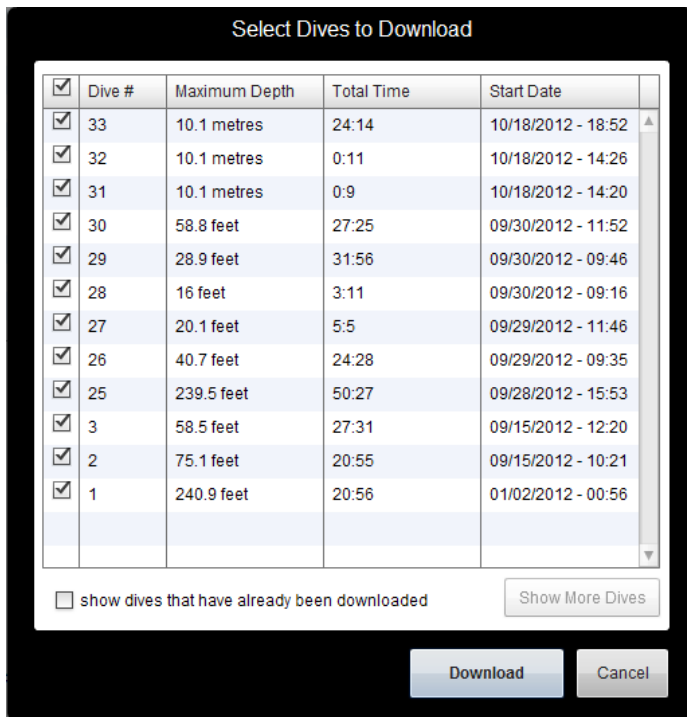

Once connected it will download a list of available dive logs and you will see a screen like this.

You can unselect any dive logs you don't want to download, or you can press “Download” to download all the dives on your NERD 2. After that, Shearwater Desktop will transfer the dives to your computer.

The first time you download dives from your NERD 2, you will be asked to give the NERD 2 a name. If you have multiple Shearwater dive computers, you will be able to easily tell which dive was downloaded from which dive computer.

DIVE LOG DOWNLOADING WITH SHEARWATER CLOUD MOBILE

In Shearwater Cloud Mobile, connect to the dive computer, and select download dives.

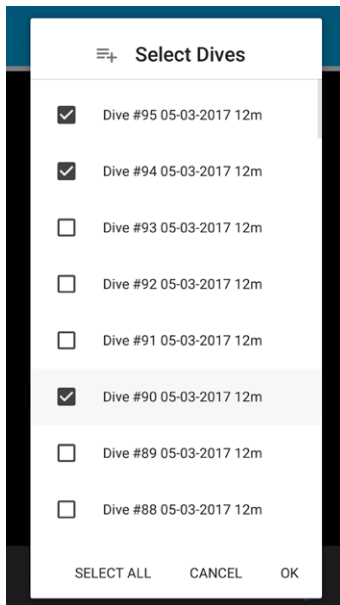
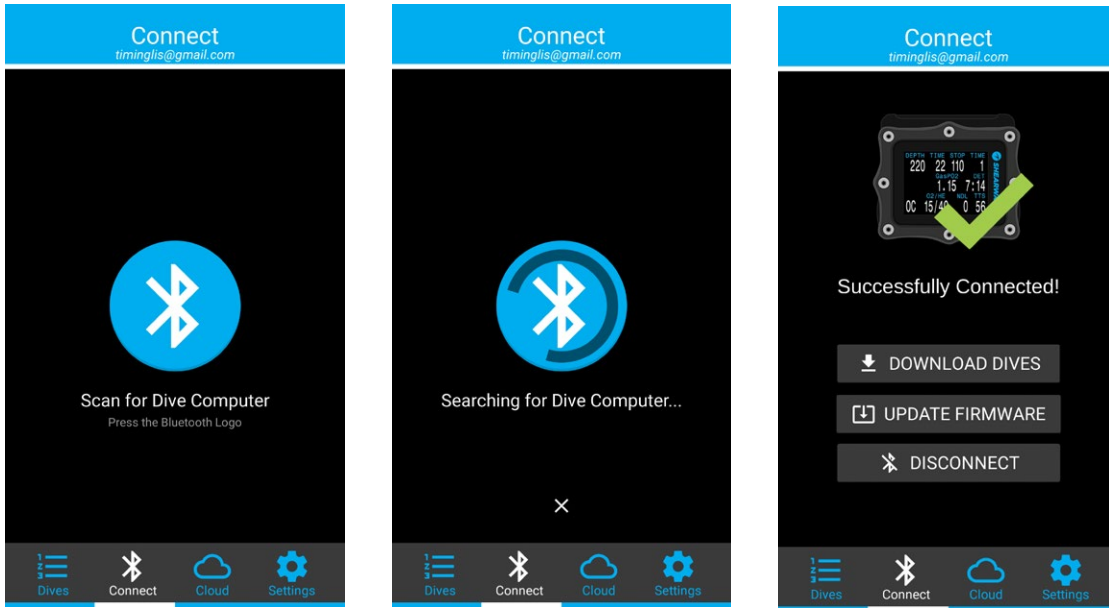

Once connected it will download a list of available dive logs and you will see a screen like this.

Select any dive logs you want to download. After that, Shearwater Cloud Mobile will transfer the dives to your Phone.

CHARGING

ATTACH THE NERD 2 CHARGING CLIP

Align the charging pins on the clip with the pins on the NERD 2 using the clip guides atop the charging clip. Connect the clip by applying pressure to the bottom of the clip until it snaps into place. USB port on top.

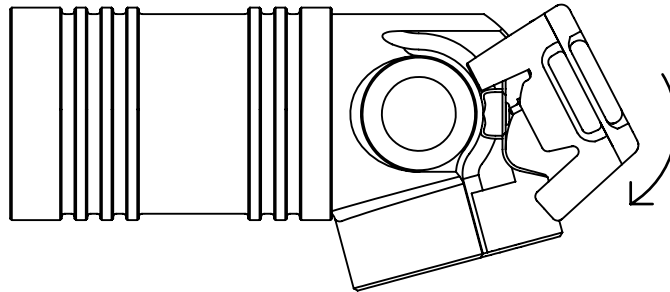

A retention strap is included to help secure the charging clip, allowing it to charge in rougher conditions.

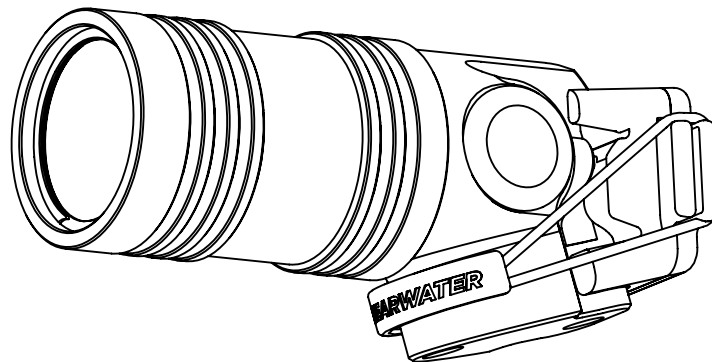

NERD 2 charging input is 5V DC at 200mA max.

Do not apply greater than +/- 10V DC to charger pins. Maximum voltage for charging is 9V DC.

BATTERY CARE

Lithium-ion batteries, such as the one in the NERD 2, can be damaged if completely discharged. The NERD 2 has internal protection which disconnects the battery before complete discharge occurs. However, a small amount of self-discharge still occurs, which can lead to complete discharge and thus battery damage if stored for long periods without recharging.

To prevent damage to the battery please do the following:

- 1) Fully charge the NERD 2 prior to storage
- 2) Top up the NERD 2 battery every 6 months

CHARGING TIME

The NERD 2 can be charged with any USB wall power adaptor or with a computer. Charging time is approximately 3-4 hours.

BEHAVIOR ON DEAD BATTERY



We recommend that you never allow the battery fully discharge to prevent damage.

Settings

All settings are retained permanently. No loss of settings occurs if the battery dies.

Clock

The clock (time and date) is saved to permanent memory every 16 seconds when the NERD 2 is on, and every 5 minutes when off. If the battery dies, the clock stops running. Once the battery is charged, the clock is restored to the last saved value.

Once the battery is charged, you will be prompted to update the Clock and Date.



The NERD 2 uses a highly accurate quartz crystal for time keeping. Expected drift is about 1 minute per month. If you notice drift, it is easily corrected in the **System Setup Menu**.

Decompression tissue loading

If the battery dies between repetitive dives. It is safe to recharge the unit and continue diving.

Like the clock, the decompression tissue loading is saved every 16 seconds to permanent memory when on, and every 5 minutes when off.

When the battery dies, the tissues remain stored in the permanent memory and are restored once the battery is charged. However, the NERD 2 does not know for how long the battery was dead, so no surface interval adjustment is applied for the time the battery was dead.

For quick dead-battery intervals, the un-powered time interval is not significant. However, if the battery dies shortly after a dive and remains dead for a long period, then residual tissue loading will remain when the battery is charged again. If you have not been diving for more than 4 days, it is safe to reset the tissues to their default levels (System Setup->Reset to Defaults->Tissues Only). Otherwise, leave the tissues as is and accept the slightly higher conservatism for the next dive.

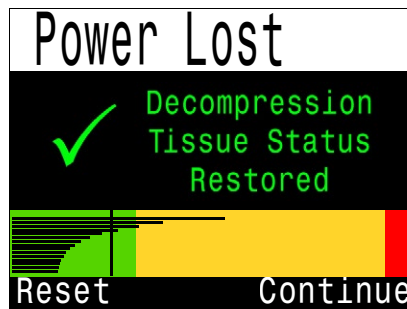

After a dead battery re-boot, the restored tissues are shown (with shortcut to reset)

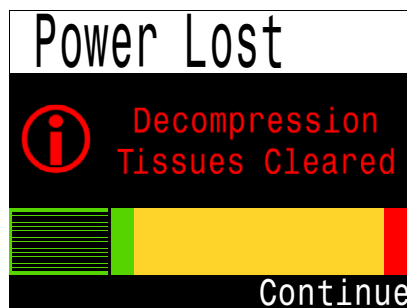

Resetting the deco tissues sets them to saturated with air at the current atmospheric pressure

If at the time of a dead battery re-boot any tissue is below saturated with air at the current pressure, then that tissue is brought up to being saturated with air. This might happen after a decompression dive that used 100% O₂, where the faster tissues are often completely depleted of inert gas loading. Bringing such tissues back up to saturated with air after a dead battery re-boot is the most conservative approach.

When deco tissues are reset, the following are also reset:

- Inert gas tissue loadings set to saturated with air at current atmospheric pressure
- CNS Oxygen Toxicity set to 0%
- Surface Interval time set to 0
- All VPM-B values set to default levels



LIMITATIONS OF ALARMS

All alarm systems share common weaknesses.

They can alarm when no error condition exists (false positive). Or they can fail to alarm when a real error condition occurs (false negative).

So by all means respond to these alarms if you see them, but **NEVER** depend on them. Your judgment, education, and experience are your best defenses. Have a plan for failures, build experience slowly, and dive within your experience.

ALERT DISPLAYS

The system has several displays that alert to warnings, errors, and information alerts.

Each alert will remain in the bottom row of the main screen until it is dismissed by pressing the SELECT (right) button.

Warning alerts are displayed in **Red** and indicate you are in immediate danger and must take action.

Error alerts are displayed in **yellow** and indicate a computer error.

Info alerts displayed in **Green** denote notifications.

Highest priority alerts are listed first. If multiple alerts occur simultaneously, the alert with the highest priority will be displayed. Clear that alert by pressing the SELECT (right) button to see the next alert.

Alert	Description	Solution
Low PPO2	The PPO2 is below the limit set on the Adv. Config. page (default 0.19)	Change your breathing gas to one safe for the current depth.
High PPO2	The PPO2 is above the limit set on the Adv. Config. page (default 1.65)	Change your breathing gas to one safe for the current depth.
Missed Stop	A required decompression stop was violated.	Descend to deeper than the currently displayed stop depth. Monitor for symptoms of DCS. Use extra conservatism for future repetitive dives.
Fast ascent	The ascent was sustained at faster than 10m/min (33 feet/min).	Use a slow ascent rate. Monitor for symptoms of DCS. Use extra conservatism for future repetitive dives.
Tissues Cleared	The decompression tissue inert gas loading has been set to default levels.	Plan repetitive dives accordingly.

Alert	Description	Solution
Low Battery Int.	The internal battery is low.	Recharge the battery.
High CNS	Central Nervous System (CNS) toxicity clock high exceeded 90%.	Switch to a gas with a lower PPO2 or ascend shallower (decompression ceiling allowing).
Watchdog Reset	The computer has reset to recover from an unexpected software condition.	Please report to Shearwater Research Inc.
Reset to Defaults	A notification that the reset has been completed.	N/A
New Unlock	A notification that a new unlock has been applied.	N/A
Upgrade Failed	Firmware update failed, possibly due to a communications error or corrupted file.	Try the firmware upgrade again. Contact Shearwater if problem persists.
Various other system level errors	Other messages than those above may be shown for system level failures.	Please report to Shearwater Research Inc.

i CONTACT SHEARWATER

This is not an exhaustive list. Please contact us if you experience any unexpected errors: info@shearwater.com

The center row also shows permanent "Low PPO2" or "High PPO2" messages when the PPO2 is not in a safe range. These message will clear automatically once a safe PPO2 is restored.

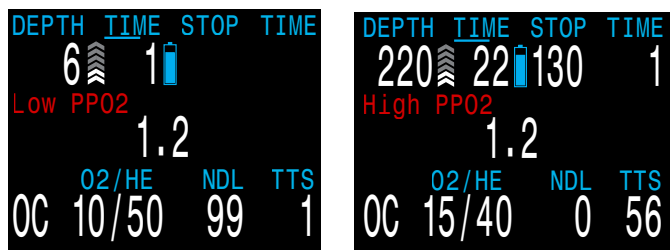

Sample alerts on center row

ALERT DISPLAY SCREENS

These sample screens correspond to the errors listed above.

Each of the alerts will display the message until dismissed. The error is dismissed by pressing SELECT.

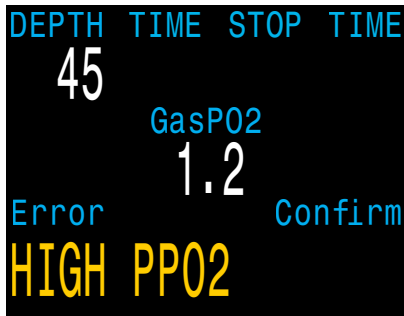

PPO2

This message will appear if the average PPO2 goes above 1.6 for more than 30 seconds.

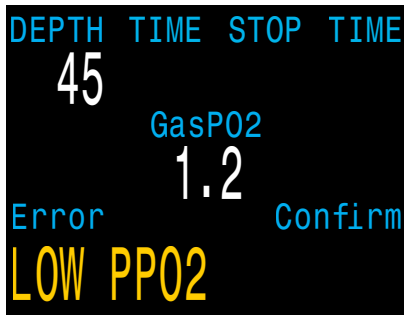

This message will appear if the average PPO2 goes below 0.4 (.19 for OC or SC) for more than 30 seconds.

It is not unusual to get this error immediately after submerging with a manual CCR and a hypoxic mix. The first breath after submerging floods the loop with low PPO2 gas. The situation is usually resolved by increasing depth such that when the error is noticed, the PPO2 is no longer low.

This condition will also cause the “**LOW PPO2**” display to appear. If the computer does not have two sensors that have confirming values. There is no way to know the actual PPO2, and the average PPO2 will be calculated as 0.11 (the lowest value is the most conservative for decompression calculations).

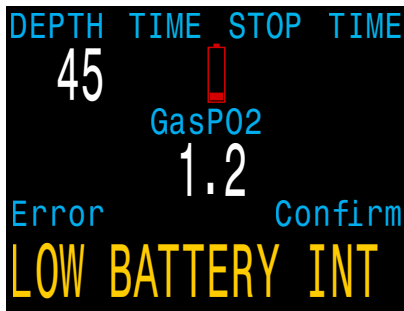

Battery

This message will appear when your internal battery is low for 30 seconds. The battery needs to be charged. The computer will also flash the battery symbol red.

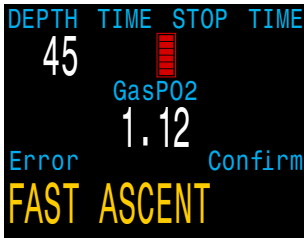

Ascent

This alarm is a notification that there has either been a very fast ascent for a short period of time, or that there has been an ascent of more than 66 fpm / 20 mpm maintained for over a minute. This alarm may return after being dismissed if the condition occurs again.



Deco

The alarm occurs when the diver has been above the minimum depth for a decompression stop for more than one minute. This alarm will only appear once during a dive, but it will also appear once on the surface after the dive.

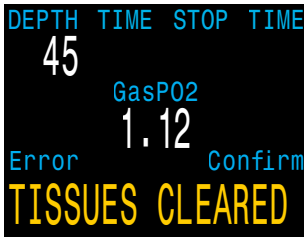

Tissues Cleared

This alarm will show when the decompression tissues are cleared. All decompression information has been lost.



Watchdog Reset

This alarm happens when the computer does not complete all of its tasks in the time allotted. It can happen occasionally from a transient problem like a battery bounce after an impact. It can also be the result of a hardware problem.

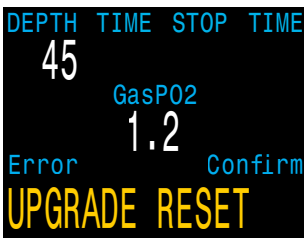

Upgrade Reset

This reset shows up after a software update. This is the normal event that shows the computer has been rebooted after the software update.

STORAGE AND MAINTENANCE

The NERD 2 dive computer should be stored dry and clean, and fully charged.

Do not allow salt deposits to build up on your dive computer. Wash your computer with fresh water to remove salt and other contaminants. **Do not use detergents or other cleaning chemicals** as they may damage the NERD 2 dive computer. Allow to dry naturally before storing.

Do not wash under high pressure jets of water as it may cause damage to the depth sensor.

Store the NERD 2 dive computer **out of direct sunlight** in a cool, dry and dust free environment. Avoid continuous exposure to direct ultra-violet radiation and radiant heat.

Servicing

- ⚡ There are no user serviceable parts inside the NERD 2.
- ⚡ Do not attempt to open the NERD 2.
- ⚡ Clean with water ONLY. Any solvents may damage the dive computer.
- ⚡ Service of the NERD 2 may only be done at Shearwater Research, or by any of our authorized service centers.
- ⚡ There is no specified service interval, however, it is recommended that the battery be replaced by an authorized service center after 5 years or 500 cycles.
- ⚡ Your nearest service center can be found at www.shearwater.com/contact

SPECIFICATIONS

Specification	Stand Alone (SA)	Fischer (FC)	DiveCAN Controller (DCC)	DiveCAN Monitor (DCM)
Operating Modes	OC Tec OC Rec CC/BO (int. PPO2) Gauge	OC Tec OC Rec CC/BO SC/BO Gauge PPO2	CC/BO	OC Tec OC Rec CC/BO SC/BO Gauge PPO2
Decompression Model	Bühlmann ZHL-16C with GF VPM-B and VPM-B/GFS (optional)			
Display	Full color 0.2" QVGA LCD with always on LED backlight Appears equivalent to a 24" screen at 10ft.			
Pressure (depth) sensor	Piezo-resistive			
Calibrated Range	0 Bar to 30 Bar			
Accuracy	+/-50 mBar (at surface) +/-100 mBar (at 14bar)			
Crush Depth Limit	31 Bar (~300msw)			
Surface Pressure Range	500 mBar to 1040 mBar			
Depth of dive start	1.6 m of sea water			
Depth of dive end	0.9 m of sea water			
Operating Temperature Range	+4°C to +32°C			
Operating Temperature Range	0°C to +40°C			
Long-Term Storage Temperature Range	+5°C to +30°C			
Battery	Internal rechargeable lithium-ion			
Battery Operating Life (Display Medium Brightness)	18 Hours			
Shelf Life Between Charges	6 months			
Communications	Bluetooth Smart			
Compass Resolution	1°			
Compass Accuracy	±5°			
Compass Tilt Compensation	±45° roll, ±135° pitch			
Dive Log Capacity	Approximately 1000 hours			
Weight (including cable)	74 g	148g	159g	159g
Size (W X L X H)	33mm x 85.81mm x 44mm			

FCC WARNING

a) USA-Federal Communications Commission (FCC)

This equipment has been tested and found to comply with the limits for a Class B digital device, pursuant to Part 15 of FCC Rules. These limits are designed to provide reasonable protection against harmful interference in a residential installation. This equipment generates, uses, and can radiate radio frequency energy. If not installed and used in accordance with the instructions, it may cause harmful interference to radio communications. However, there is no guarantee that interference will not occur in a particular installation.

If this equipment does cause harmful interference to radio or television reception, which can be determined by tuning the equipment off and on, the user is encouraged to try and correct the interference by one or more of the following measures:

- Reorient or relocate the receiving antenna
- Increase the distance between the equipment and the receiver.
- Connect the equipment to outlet on a circuit different from that to which the receiver is connected.
- Consult the dealer or an experienced radio/TV technician for help.

Any changes or modifications not expressly approved by the party responsible for compliance could void the user's authority to operate the equipment.

Caution: Exposure to Radio Frequency Radiation.

This device must not be co-located or operating in conjunction with any other antenna or transmitter.
Contains TX FCC ID: 2AA9B05

INDUSTRY CANADA WARNING

b) Canada - Industry Canada (IC)

This device complies with RSS 210 of Industry Canada.
Operation is subject to the following two conditions:

- (1) this device may not cause interference, and
- (2) this device must accept any interference, including interference that may cause undesired operation of this device.

L'utilisation de ce dispositif est autorisée seulement aux conditions suivantes :

- (1) il ne doit pas produire d'interférence, et
- (2) l'utilisateur du dispositif doit être prêt à accepter toute interférence radioélectrique reçue, même si celle-ci est susceptible de compromettre le fonctionnement du dispositif.

Caution: Exposure to Radio Frequency Radiation.

The installer of this radio equipment must ensure that the antenna is located or pointed such that it does not emit RF field in excess of Health Canada limits for the general population; consult Safety Code 6, obtainable from Health Canada's [website](#).
Contains TX IC: I2208A-05

CONTACT

**Shearwater Research Inc.
Headquarters**
13155 Delf Place, Unit 250
Richmond, BC
V6V 2A2
Tel: +1.604.669.9958
info@shearwater.com

**EU Service Center
Narked at 90 Ltd**
15 Bentley Court,
Paterson Rd,
Wellingborough,
Northants, UK
NN8 4BQ
Tel: +44.1933.681255
info@narkedat90.com

**US Service Center
Rebreathers USA, LLC.**
1316 142nd PL SE
Mill Creek, WA
98012, US
Tel: +1.425.418.1425
usaservice@shearwater.com

**Asia/Pac Service Center
Paul Trainor (Underwater Obsession)**
287 Happy Valley Road
Owhiro Bay, Wellington
6023, NZ
Tel: +64.27.6128265
asiapacservice@shearwater.com

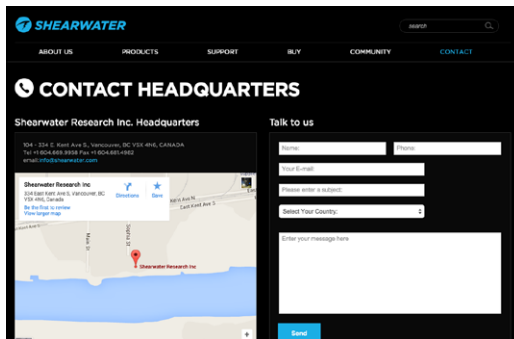

www.shearwater.com



www.facebook.com/DiveShearwater



www.twitter.com/DiveShearwater

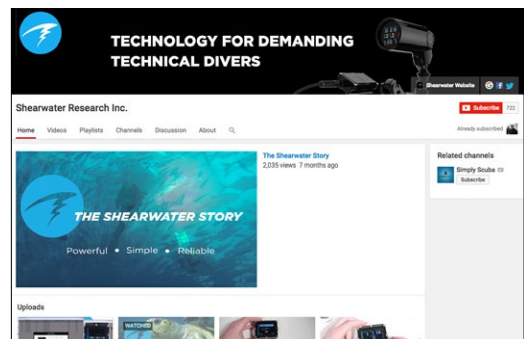

www.youtube.com/shearwaterresearch

End of Manual